

Introduction

This user guide provides detailed information about using the Microchip Radio Test 3 tool (MCHPRT3) with the Microchip PIC32CX-BZ36. The MCHPRT3 enables the user to evaluate and demonstrate the RF performance, calibration and functionalities of the PIC32CX-BZ36.

Note: In this user guide, the MCHPRT3 tool with the PIC32CX-BZ36 Curiosity Board is only shown as an example.

The MCHPRT3 is intended for development purposes. Any production test must use either a third-party production tool or users must develop their own production tool based on the DLL release.

Features

- DLL Version – DLL Information and Firmware Support Version
- COM PORT – COM Port Information and Configuration
- Baud Rate – 115200 (Default Value)
- RF Bluetooth® – Bluetooth Low Energy RF Parameter Configuration and Information
- RF ZB – Zigbee® RF Parameter Configuration and Information
- MAC Address Information and Configuration
- IB File – Read or Save Information Block (IB) File
- Calibration Information and Configuration
- GPIO Information and Configuration

For more details, refer to [Getting Started](#).

Table of Contents

Introduction	1
Features	1
1. Quick References	3
1.1. Hardware Prerequisites.....	3
1.2. Software Prerequisites.....	3
1.3. Acronyms and Abbreviations.....	3
2. Overview.....	4
3. MPLAB X IDE HUT Code Programming Process	5
4. Getting Started.....	7
4.1. Getting Started with MCHPRT3.....	8
4.2. Getting Started with MCHPRT3 PIC32CX-BZ36 GUI	10
4.3. MCHPRT3 PIC32CX-BZ36 GUI Demonstration	11
5. Document Revision History.....	26
Microchip Information.....	27
Trademarks.....	27
Legal Notice.....	27
Microchip Devices Code Protection Feature.....	27

1. Quick References

1.1. Hardware Prerequisites

- PIC32CX-BZ36 Curiosity Board (PIC32CX-BZ36 programmed with HUT Firmware)
- USB-A to Micro USB cable
- Bluetooth Low Energy and Zigbee Tester (IQxel)

1.2. Software Prerequisites

Download the latest MCHPRT3 installer package, PIC32CX-BZ36 HUT X.X firmware and the corresponding tools from the Microchip website at www.microchip.com/MCHPRT.

- Windows® OS (version to be confirmed)
- MCHPRT3 installer package (MCHPRT3_Setup_v1.0.x.XXXX.exe)
- MPLAB® X IDE v6.10 or above

1.3. Acronyms and Abbreviations

Table 1-1. Acronyms and Abbreviations

Acronyms and Abbreviations	Description
CLI	Command Line Interface
DLL	Dynamic Link Library
DUT	Device Under Test
GPIO	General-Purpose Input/Output
GUI	Graphical User Interface
HUT	Hardware Under Test
IB	Information Block
MCHPRT3 tool	Microchip Radio Test 3 tool
OTP	One-Time Programmable
RSSI	Received Signal Strength Indicator

2. Overview

This section provides an overview of the MCHPRT3 tool setup and the components. Install the MCHPRT3_setup_v1.0.1.XXXX.exe tool available in the C:\Microchip\ folder.

The following table provides the MCHPRT3 tool package files:

Table 2-1. MCHPRT3 Tool Package Files

File Name	Description
MCHPRT3.exe file	MCHPRT3 executable file
MCHPRT3_CLI.exe file	MCHPRT3 CLI executable file
uninstall.exe file	Uninstall the MCHPRT3 tool
vc_redist.x86.exe file	Microsoft® Visual C++ Redistributable (x86) executable file

The following table provides the PIC32CX-BZ36 package files:

Table 2-2. PIC32CX-BZ36 Package Files

File Name	Description
HEX file (.hex file)	Hardware Under Test (HUT) firmware version file
PIC32CX-BZ36.chm	PIC32CX-BZ36 compiled HTML help file
PIC32CX-BZ36.dll file	PIC32CX-BZ36 dynamic link library file
PIC32CX-BZ36_CDECL.dll file	Default calling convention file for C and C++ programs
PIC32CX-BZ36_CLI.dll file	PIC32CX-BZ36 command line dynamic link library file
PIC32CX-BZ36_GUI.dll file	PIC32CX-BZ36 graphical user interface dynamic link library file
Release_note.txt	Tool release note file

Figure 2-1. MCHPRT3 Package Contents

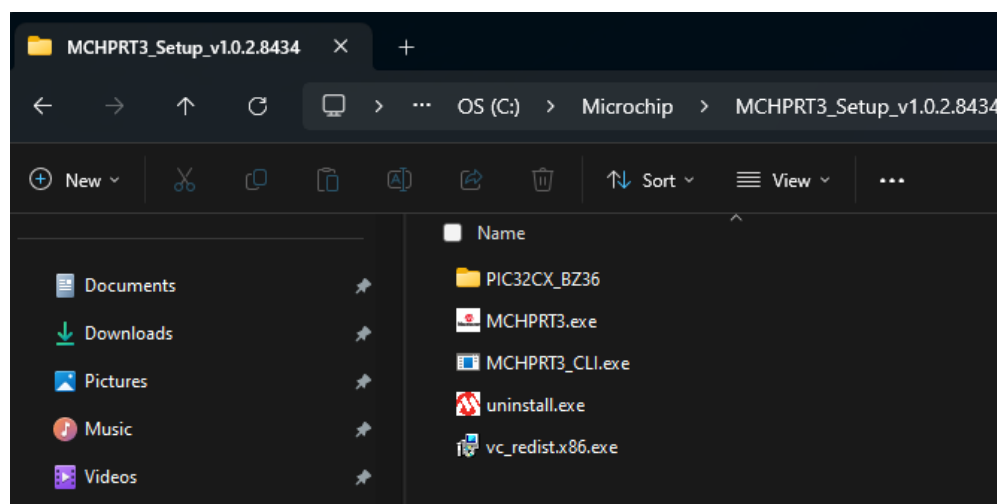

3. MPLAB X IDE HUT Code Programming Process

In this demonstration, the user can program the HUT firmware to the PIC32CX-BZ36 device using a PC with the installed MPLAB Integrated Programming Environment (IPE).

Figure 3-1. MPLAB X IPE

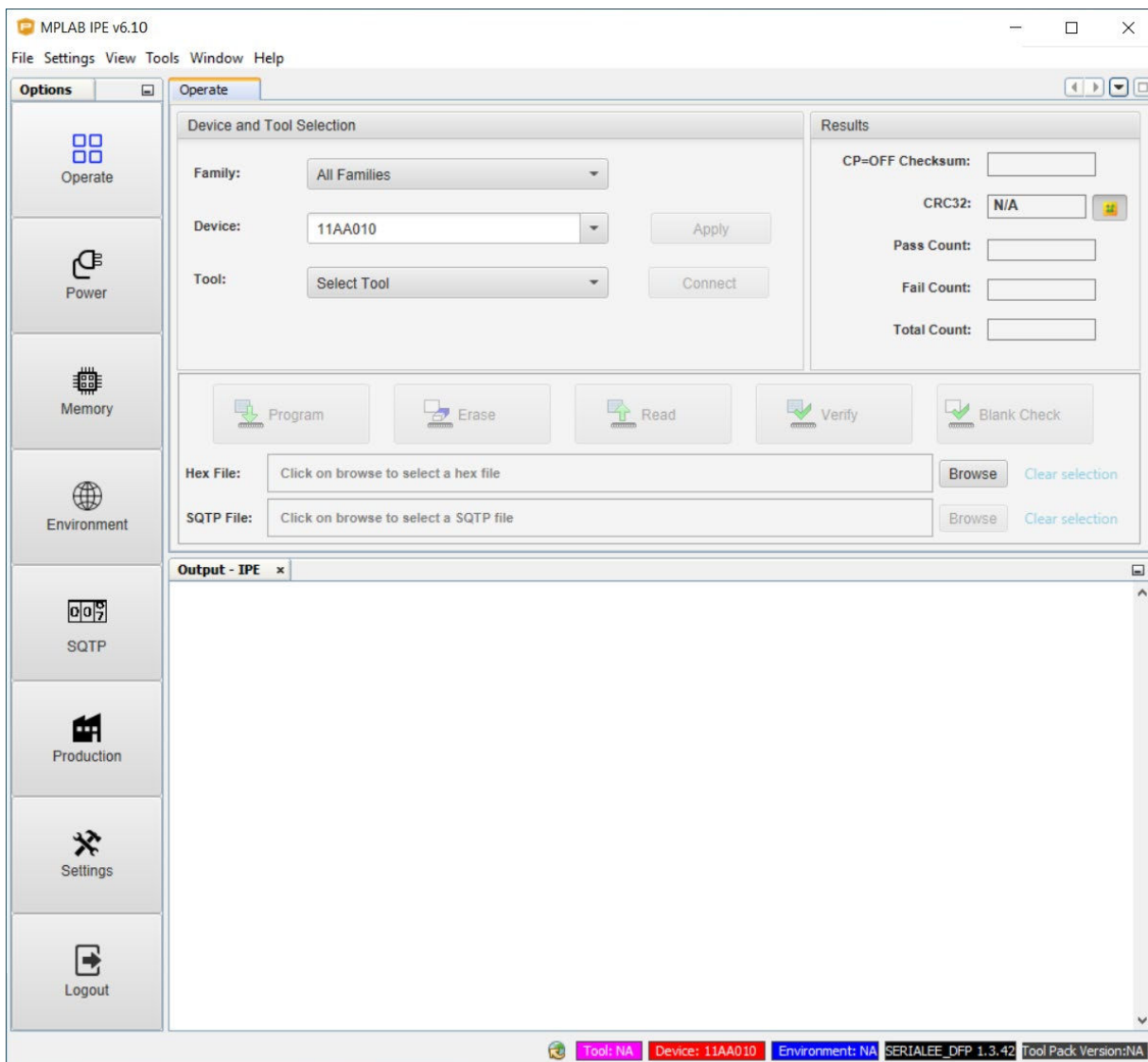

Perform the following steps for HUT firmware programming:

1. Set up the connection between the PIC32CX-BZ36 Curiosity Board and PC. Refer to [Getting Started with MCHPRT3](#).
 - a. Start "MPLAB X IPE", then check for *PIC32CX5109BZ31048* in the "Device" text box. If it is not there, check the USB connection (step 1).
 - b. Click **Apply**.
 - c. Click **Browse** to load the `PIC32CX-BZ36_hut.hex`, which is the PIC32CX-BZ36 HUT X.X firmware.
 - d. Click **Program**, then wait one minute for the programming to complete.

Figure 3-2. MPLAB X IPE (Programming Complete)

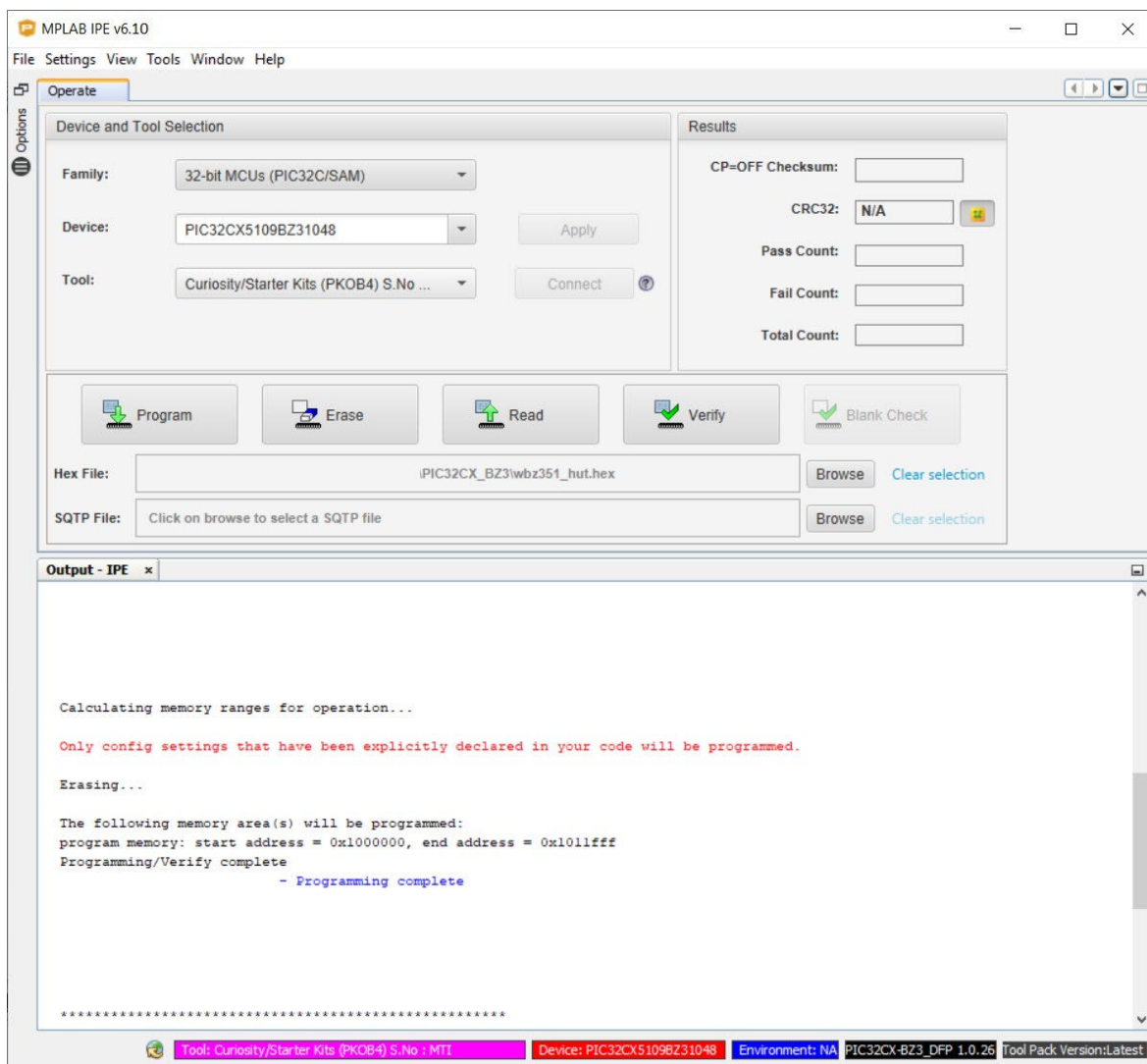

2. The PIC32CX-BZ36 is programmed with the HUT X.X firmware and ready for the test using the PIC32CX-BZ36 MCHPRT3 tool.

4. Getting Started

This section describes how to use the MCHPRT3 GUI to test or calibrate the PIC32CX-BZ36 with the Bluetooth Low Energy and Zigbee tester.

The following figure illustrates the MCHPRT3 for PIC32CX-BZ36 GUI with the following components:

Figure 4-1. PIC32CX-BZ36 GUI

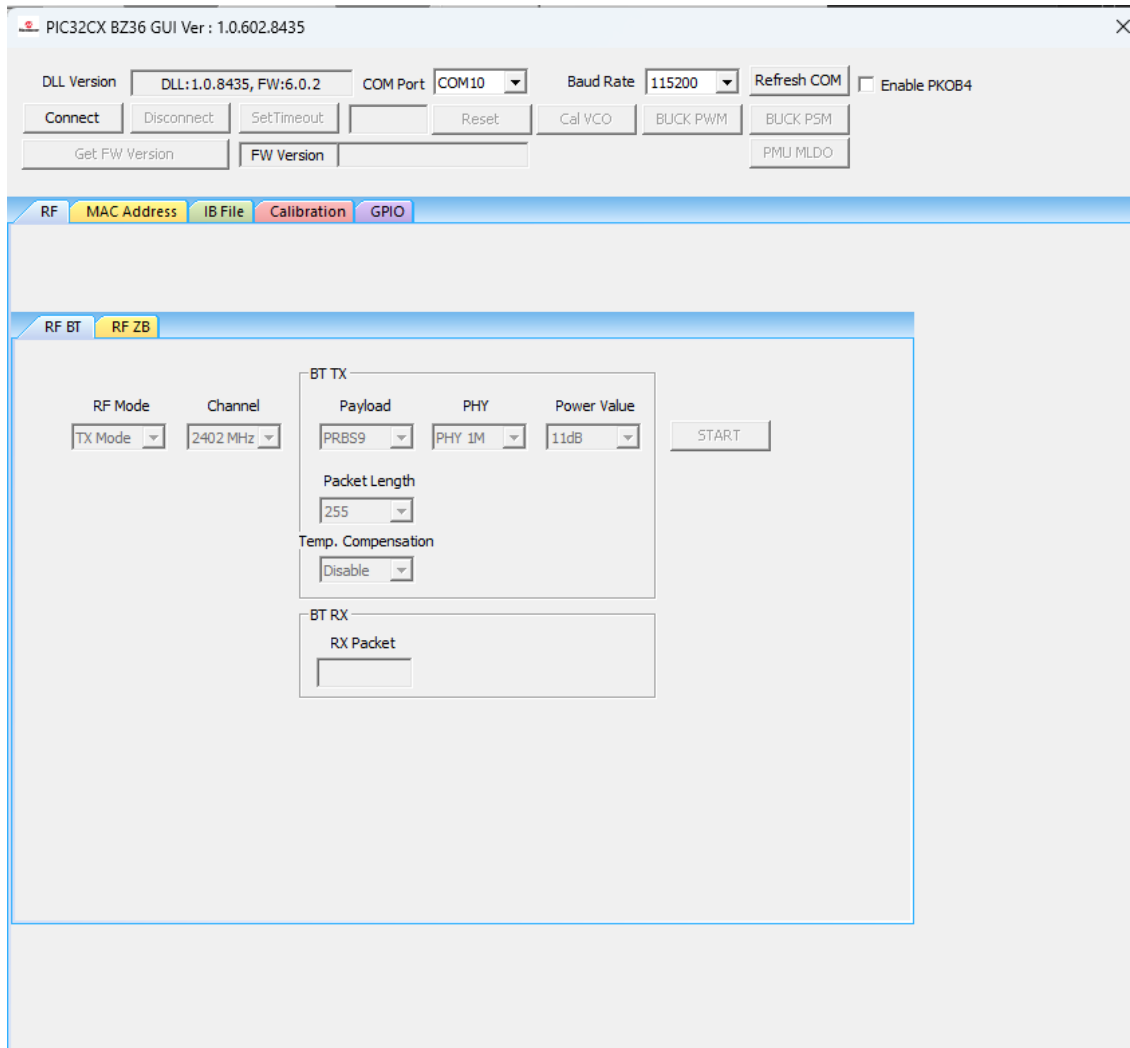

4.1. Getting Started with MCHPRT3

MCHPRT3 Package Features

- RF – RF Test for Bluetooth and Zigbee TX/RX
- Calibration – TX Calibration and RX Calibration
- MAC Address – Read/Write Bluetooth Address and Zigbee MAC Address
- Information Block (IB) File – Read/Save IB File to/from Buffer and Read/Commit IB Buffer to/from DUT
- GPIO – GPIO Test Command

Figure 4-2. MCHPRT3 Block Diagram

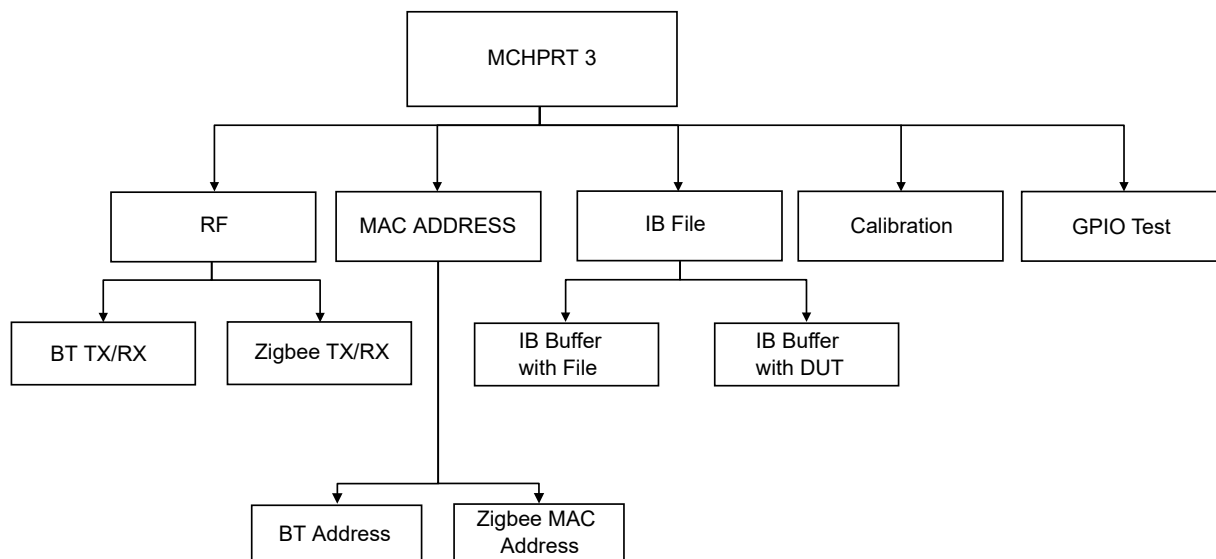

The following are the steps to launch the MCHPRT3 tool:

1. Double click `MCHPRT3.exe` under direction: `C:\Microchip\MCHPRT3_Setup_v1.0.1.XXXX;` the following screen appears.

Figure 4-3. Start-Up Window of the MCHPRT3 Tool

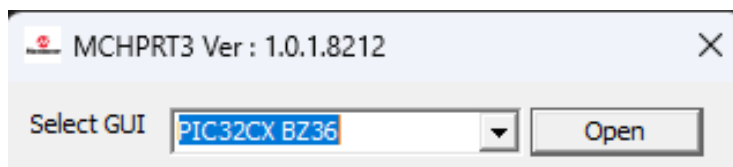

2. From the "Select GUI" drop-down list, select `PIC32CX-BZ36`.
3. Click **Open** to launch the `PIC32CX-BZ36` window (see the following figure).

Figure 4-4. PIC32CX-BZ36 GUI

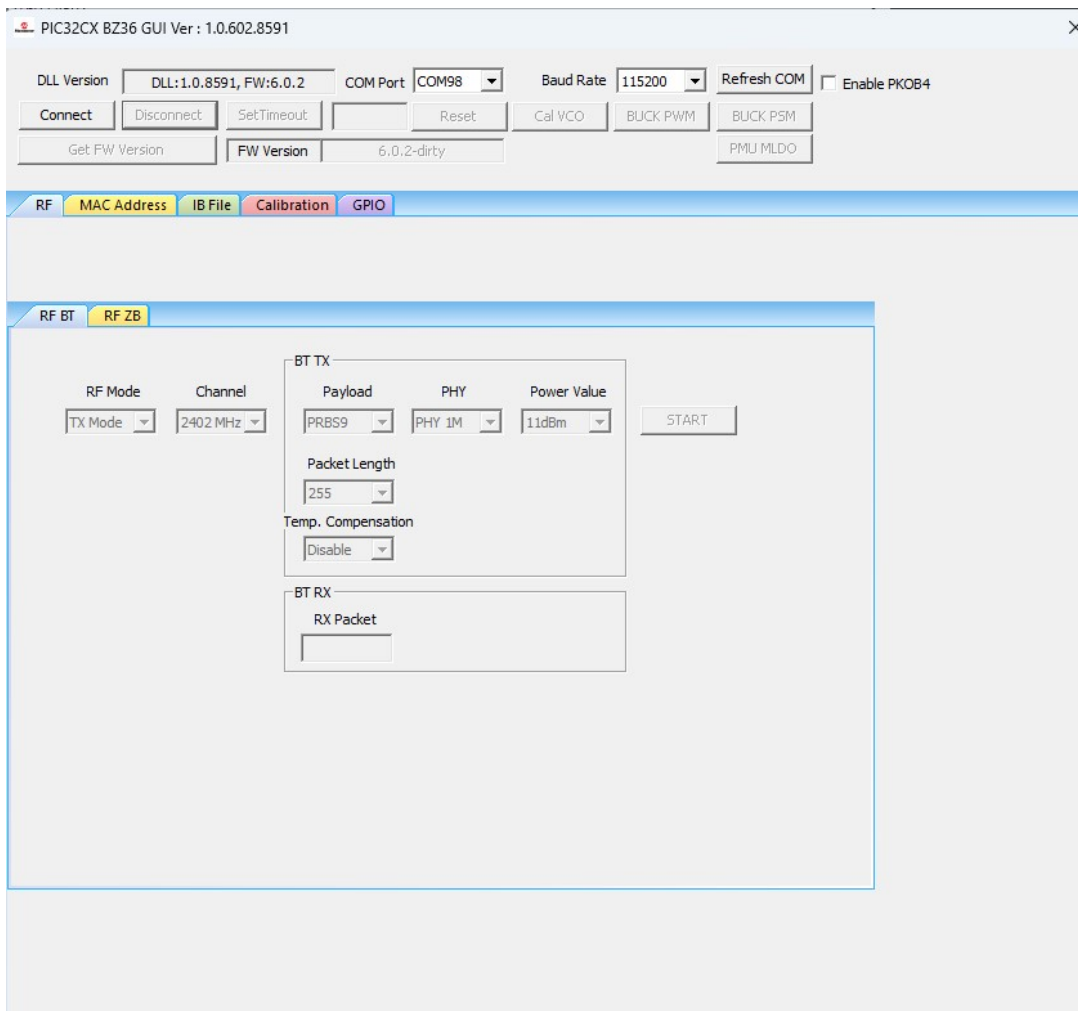

Description of each component:

- Buttons on the top:
 - **Connect/Disconnect** – Connects or disconnects the PIC32CX-BZ36
 - **Reset** – Reset the PIC32CX-BZ36
 - **Refresh COM** – Update the list of connected com port
 - **Cal. VCO** – VCO calibration
 - **BUCK PWM** – Switch the power mode into DC-DC (Buck) mode
 - **PMU MLDO** – Switch the power mode into MLDO mode
 - **Get FW Version** – Obtain the firmware version from the sample
 - **Enable PKOB4** – Only needed to check if the user is using the PIC32CX-BZ36 Curiosity Board
- RF for Bluetooth and Zigbee – Settings of RF mode, channel and TX parameter for RF test
 - BT – TX setting of payload, PHY (data rate), packet length and power step (power level). RX – number of RX packet.
 - Zigbee – TX settings of packet type, power level, delay time between each packet and packet number. RX – setting of RX data rate and number of RX packet.

- Calibration – Complete TX and RX calibration flow. The user can save calibration info to file or commit to NVM type Flash or OTP.
 - TX Calibration – Perform TX calibration flow to adjust transmitted power and output frequency to target.
 - RX Calibration – Perform RX calibration flow to obtain RX IQ, RSSI to corresponding received power and so on.
- MAC Address – Read/write address
 - BT address and Zigbee MAC address
- IB (Information Block) File
 - Read IB file to IB buffer/save IB buffer to IB file
 - Read DUT to IB buffer/commit IB buffer to DUT
- GPIO – Test GPIO for selected port, pin, in/out and level
 - Start GPIO – Initialize GPIO for test
 - GPIO Command – Execute GPIO test command for selected port, pin, in/out and level
 - Stop GPIO – Stop GPIO test

4.2. Getting Started with MCHPRT3 PIC32CX-BZ36 GUI

Program the sample before using the MCHPRT3 tool. For more details on the HUT code programming process, refer to [MPLAB X IDE HUT Code Programming Process](#).

To run an RF test on the PIC32CX-BZ36 Curiosity Board, perform the following procedure:

1. Connect the Micro USB in the Curiosity Board to the PC.
2. Check whether the jumper for the current measurement was inserted or not.
3. Run `MCHPRT3.exe`.
4. From the “Select GUI” drop-down list, select `PIC32CX-BZ36`.
5. Click **Open** to launch the PIC32CX-BZ36 window.
6. Select the respective “COM PORT” (check device manager in PC). A different USB-to-UART serial converter requires the corresponding driver; install accordingly.
7. Baud Rate - `115200` (default value)
8. Click **Connect**.
9. Click **Reset** to reset the device. The PIC32CX-BZ36 Curiosity Board is ready for RF Test, Calibration and MAC Address Programming.

Figure 4-5. PIC32CX-BZ36 Curiosity Board USB Connection

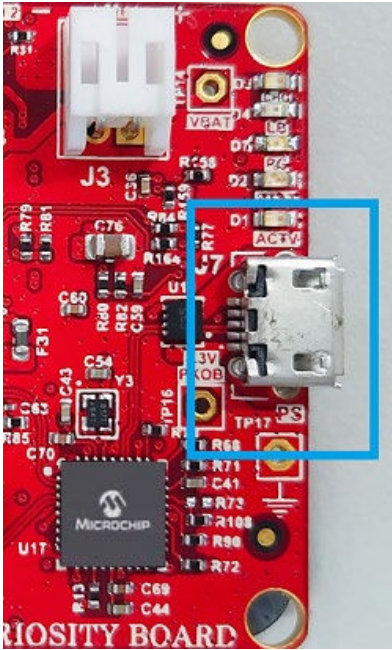
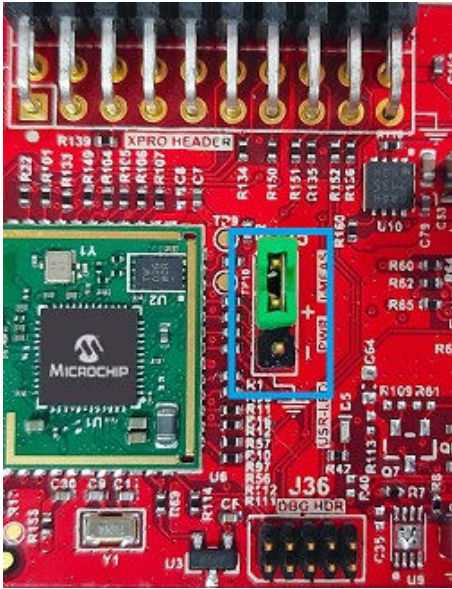

Figure 4-6. Current Measurement Jumper on PIC32CX-BZ36 Curiosity Board



4.3. MCHPRT3 PIC32CX-BZ36 GUI Demonstration

4.3.1. Bluetooth RF Test Demonstration

In this demonstration, the user can transmit Bluetooth Low Energy packets, enter RX mode and Test mode with the PIC32CX-BZ36 by using the MCHPRT3.

Perform the following steps for the demonstration of the Bluetooth RF TX modulation test:

1. Set up the connection between the PIC32CX-BZ36 Curiosity Board and PC. For more details, refer to [Getting Started with MCHPRT3](#).
2. In the **RF BT** tab, perform the following steps:
 - a. From the “RF Modes” drop-down list, select *TX Mode*.
 - b. From the “Channel” drop-down list, select *2402 MHz* for channel 37.
 - c. From the “Payload” drop-down list, select *PRBS9* (default value).
 - d. From the “PHY” drop-down list, select the *Data Rate* (1M,2M, S=2 and S=8), for example, select *PHY 1M*.
 - e. From the “Power” drop-down list, select the Output Power, for example, select *11 dB*.
 - f. From the “Packet Length” drop-down list, select the *Packet Length (0-255)*, for example, *255* (default value).
 - g. From the “Temp. Compensation” drop-down list, it is to Enable or Disable, the output power compensation according to the ambient temperature.
3. Click **START** to transmit the Bluetooth Low Energy packet.

Figure 4-7. MCHPRT3 PIC32CX-BZ36 GUI for Bluetooth RF TX Modulation Test Demonstration

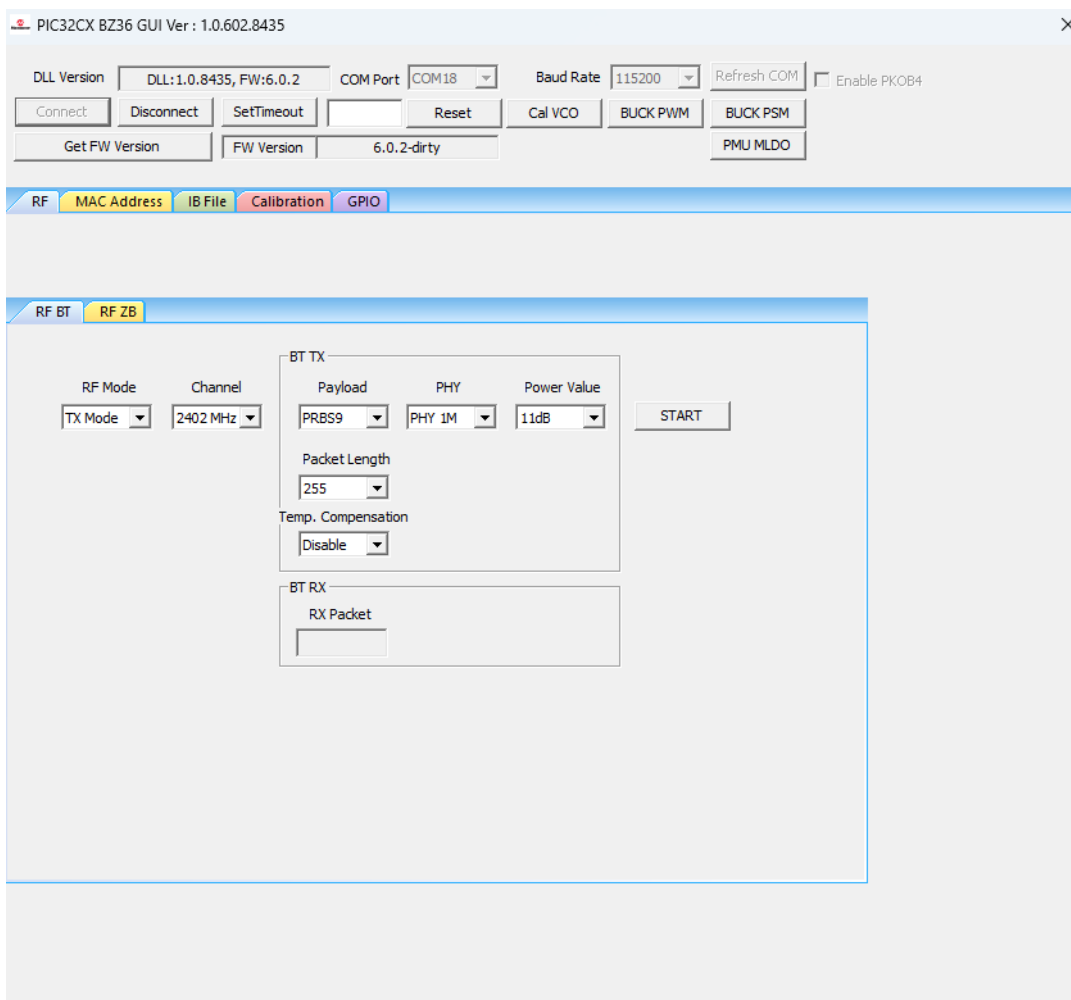

Perform the following steps for the demonstration of the Bluetooth RF RX mode:

1. Set up the connection between the PIC32CX-BZ36 Curiosity Board and PC. For more details, refer to [Getting Started with MCHPRT3](#).
2. In the **RF BT** tab, perform the following steps:
 - a. From the “RF mode” drop-down list, select *RX Mode*.
 - b. From the “Channel” drop-down list, select *2402 MHz* for channel 37.
3. Click **START** to receive the Bluetooth Low Energy packet. The number of received packets is shown in the drop-down list, “RX Packet”.

Figure 4-8. MCHPRT3 PIC32CX-BZ36 GUI for Bluetooth RF RX Mode Demonstration

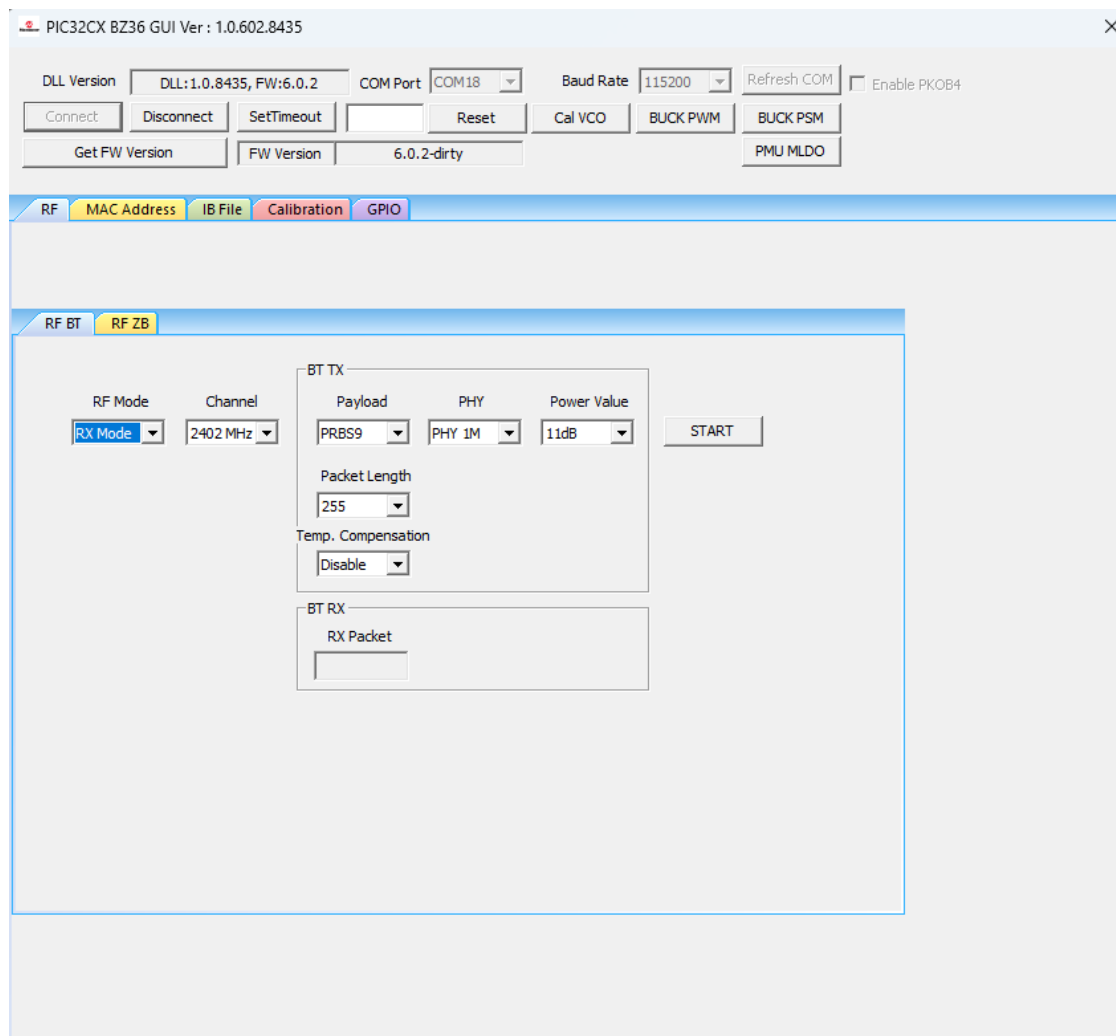

Perform the following steps for the demonstration of the Bluetooth RF CW tone test:

1. Set up the connection between the PIC32CX-BZ36 Curiosity Board and PC. For more details, refer to [Getting Started with MCHPRT3](#).
2. In the **RF BT** tab, perform the following steps:
 - From the “RF Modes” drop-down list, select *CW Mode*.
 - From the “Channel” drop-down list, select *2402 MHz* for channel 37.
 - From the “Power” drop-down list, select the Output Power, for example, select *11 dB*.
3. Click **START** to transmit the CW tone at the selected channel.

Figure 4-9. MCHPRT3 PIC32CX-BZ36 GUI for Bluetooth RF CW Mode Demonstration

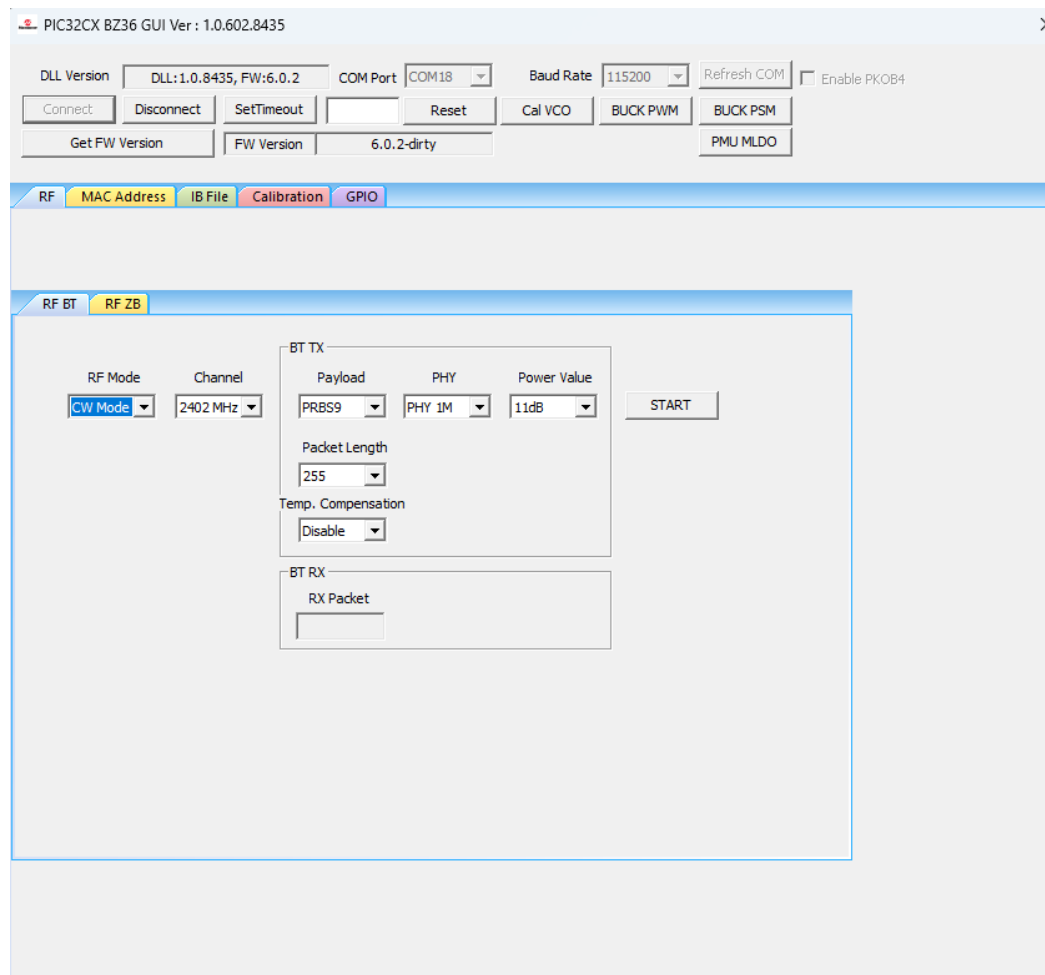

Perform the following steps for the demonstration of the Bluetooth Low Energy Test mode:

1. For the Bluetooth Low Energy Test mode, the sample must contain the following connection:
 - HCI_TXD (PA5 from the module)
 - HCI_RXD (PA6 from the module)
 - VDD (connect with external power supply)
 - Ground
2. Use the USB-to-UART serial converter to make the connection between the sample and PC by connecting the HCI_TXD, HCI_RXD and ground with the converter.
3. Power the sample with 3.3V supply.
4. Select the respective **COM PORT** (the COM port with the converter) in MCHPRT3.
5. In the **RF BT** tab, perform the following steps:
 - a. From the "RF mode" drop-down list, select *Test Mode*.
6. Click **START** to enter the Bluetooth test mode, then click **Disconnect** in the GUI. Disconnect the UART interface from the DUT while keeping the power supply, then connect it with the Bluetooth tester.

Figure 4-10. MCHPRT3 PIC32CX-BZ36 GUI for Bluetooth Test Mode Connecting with Bluetooth Tester Demonstration

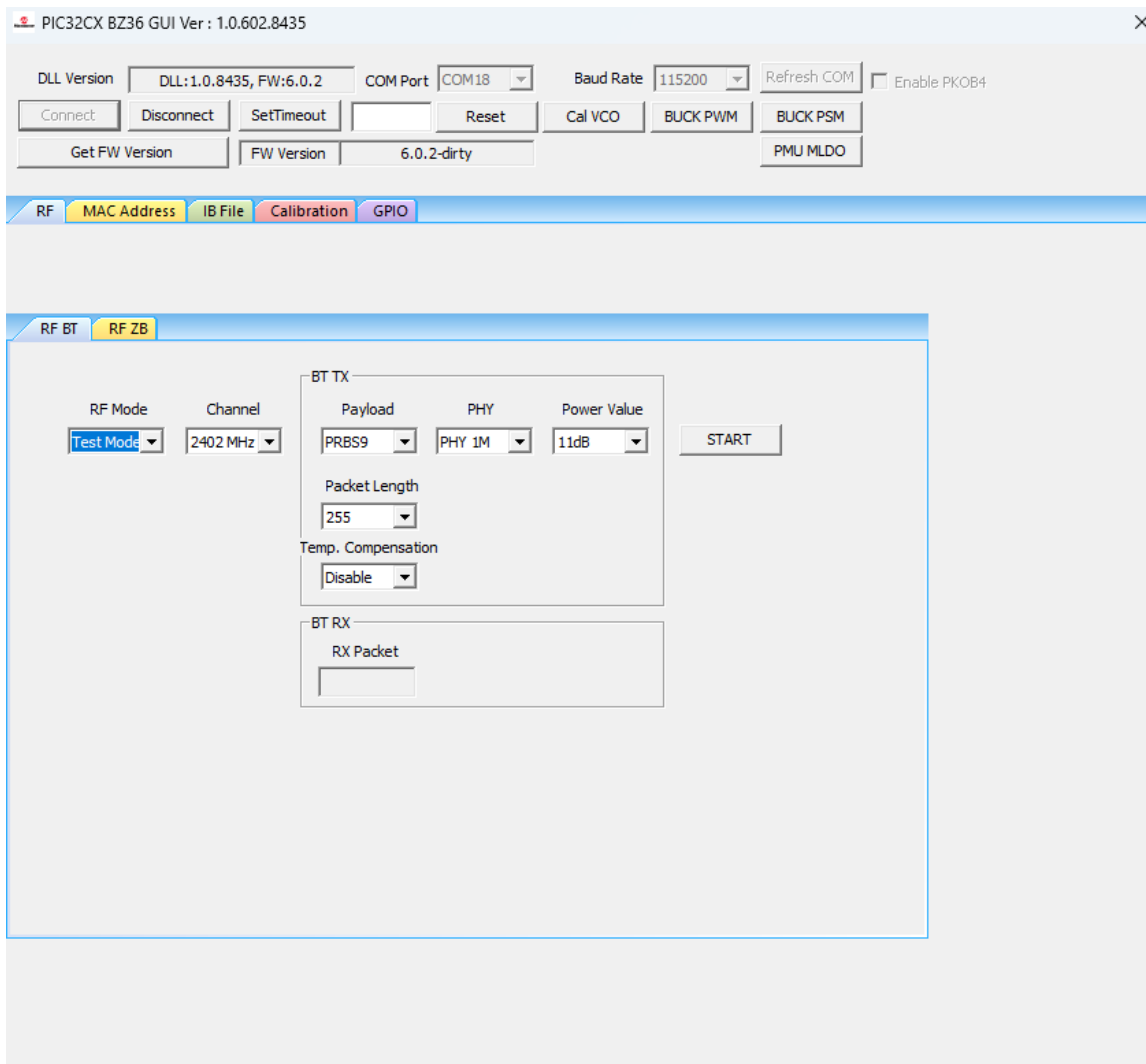

Perform the following steps for the demonstration of the Bluetooth Low Energy Adaptivity Frequency Hopping (AFH) packet transmission:

3. Set up the connection between the PIC32CX-BZ36 Curiosity Board and PC. For more details, refer to [Getting Started with MCHPRT3](#).
4. In the **RF BT** tab, perform the following steps:
 - a. From the “RF mode” drop-down list, select *AFH Mode*.
 - b. From the “Payload” drop-down list, select *PRBS9* (default value).
 - c. From the “PHY” drop-down list, select the *Data Rate* (1M,2M, S=2 and S=8), for example, select *PHY 1M*.
 - d. From the “RF mode” drop-down list, select the Output Power, for example, select 11 dB.
 - e. From the “Packet Length” drop-down list, select the *Packet Length* (0-255), for example, 255 (default value).
3. Click **START** to transmit the Bluetooth Low Energy packet with adaptivity frequency hopping.

Figure 4-11. MCHPRT3 PIC32CX-BZ36 GUI for Bluetooth Adaptivity Frequency Hopping (AFH) TX Test Demonstration

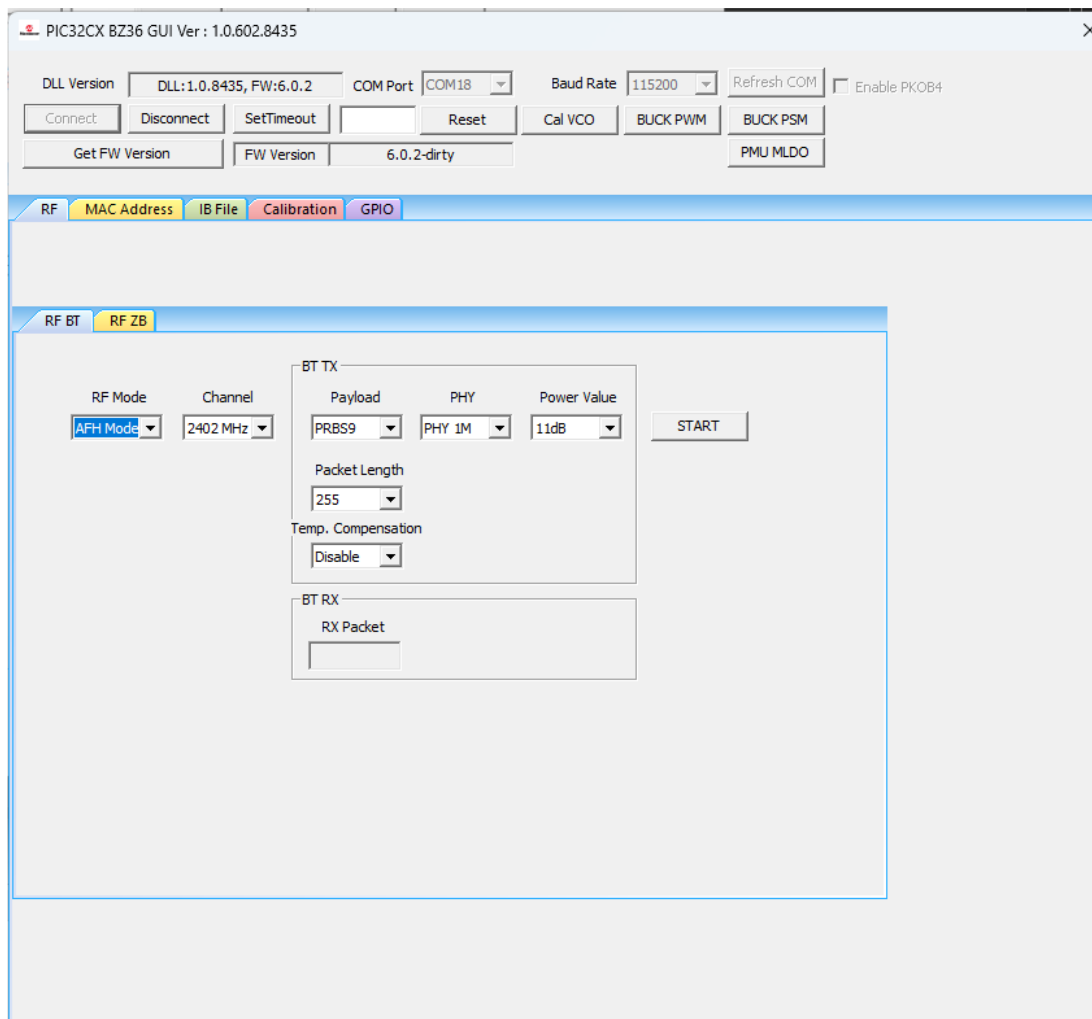

4.3.2. Zigbee RF Test Demonstration

In this demonstration, the user can transmit Zigbee packets, enter RX mode and CW mode with the PIC32CX-BZ36 by using the MCHPRT3.

Perform the following steps for the demonstration of the Zigbee packet transmission:

1. Set up the connection between the PIC32CX-BZ36 Curiosity Board and PC. For more details, refer to [Getting Started with MCHPRT3](#).
2. In the **RF ZB** tab, perform the following steps:
 - a. From the “RF Modes” drop-down list, select *TX Mode*.
 - b. From the “Channel” drop-down list, select *2405 MHz* for channel 11.
 - c. From the “Packet Type” drop-down list, select *Packet Type* as *General* (default value) or *Smallest*.
 - d. From the “Power Level” drop-down list, select *Disable* (the maximum power level is the default value).
 - e. From the “Delay Time” drop-down list, select the *Packet Delay Time (00-250)* (the default value is 10).

- f. From the “Packet Number” drop-down list, select the *Number of Transmitting Packet (00-250)* (the default value is *00, Continuous Packet Transmission*).
- g. From the “Temp. Compensation” drop-down list, it is to Enable or Disable, the output power compensation according to the ambient temperature.

3. Click **START** to transmit the Zigbee packet.

Note: The “Data Rate” must be set at 250 Kbps, and the “Delay Time” must be 10.

Figure 4-12. MCHPRT3 PIC32CX-BZ36 GUI for Zigbee RF TX Modulation Test Demonstration

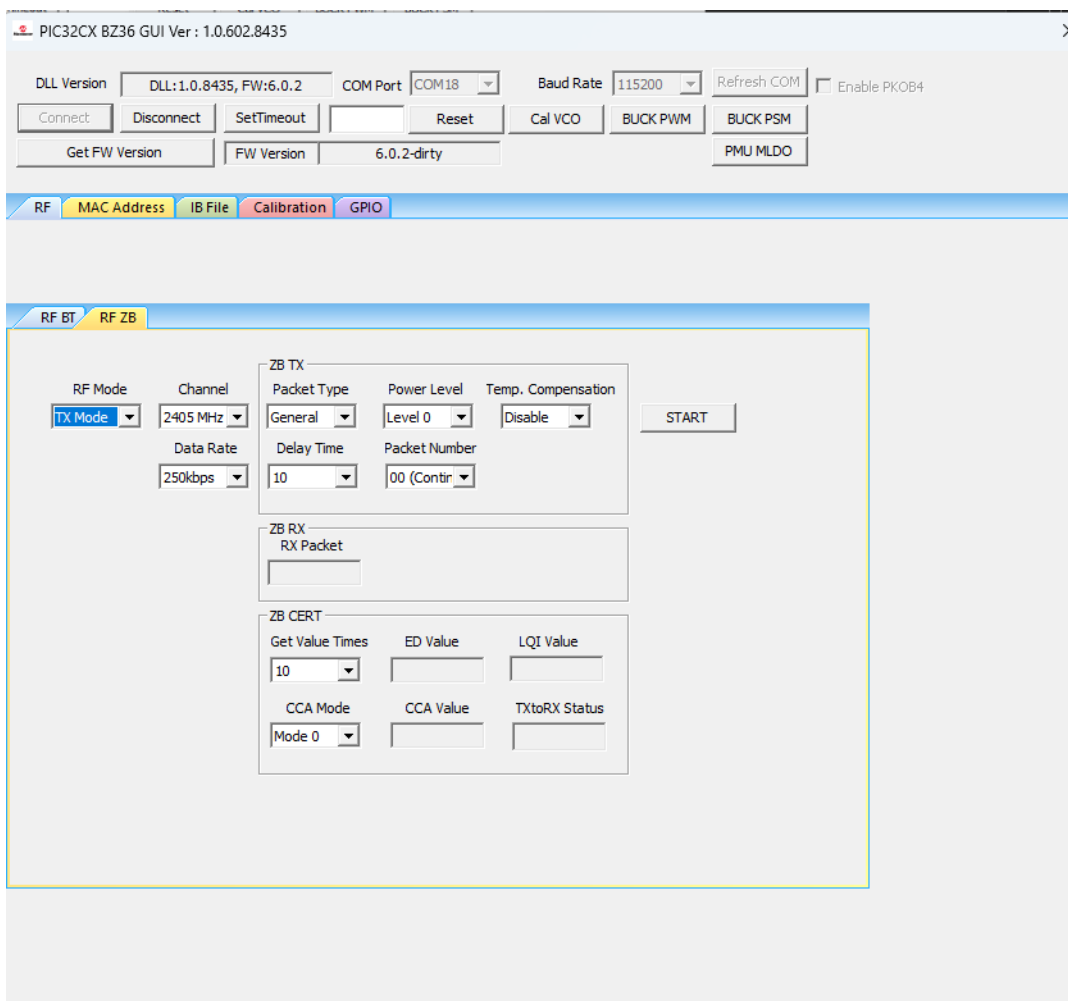

Perform the following steps for the demonstration of the Zigbee RX mode:

1. Set up the connection between the PIC32CX-BZ36 Curiosity Board and PC. For more details, refer to [Getting Started with MCHPRT3](#).
2. In the **RF ZB** tab, perform the following steps:
 - a. From the “RF Modes” drop-down list, select *RX Mode*.
 - b. From the “Channel” drop-down list, select *2405 MHz* for channel 11.
 - c. From the “RX Data Rate” drop-down list, select *Data Rate (250K, 500K, 1M and 2M)*, for example, select *250K*.
3. Click **START** to receive the Zigbee packet. The total number of received packets are available under the “RX Packet” drop-down list.

Figure 4-13. MCHPRT3 PIC32CX-BZ36 GUI for Zigbee RF RX Mode Demonstration

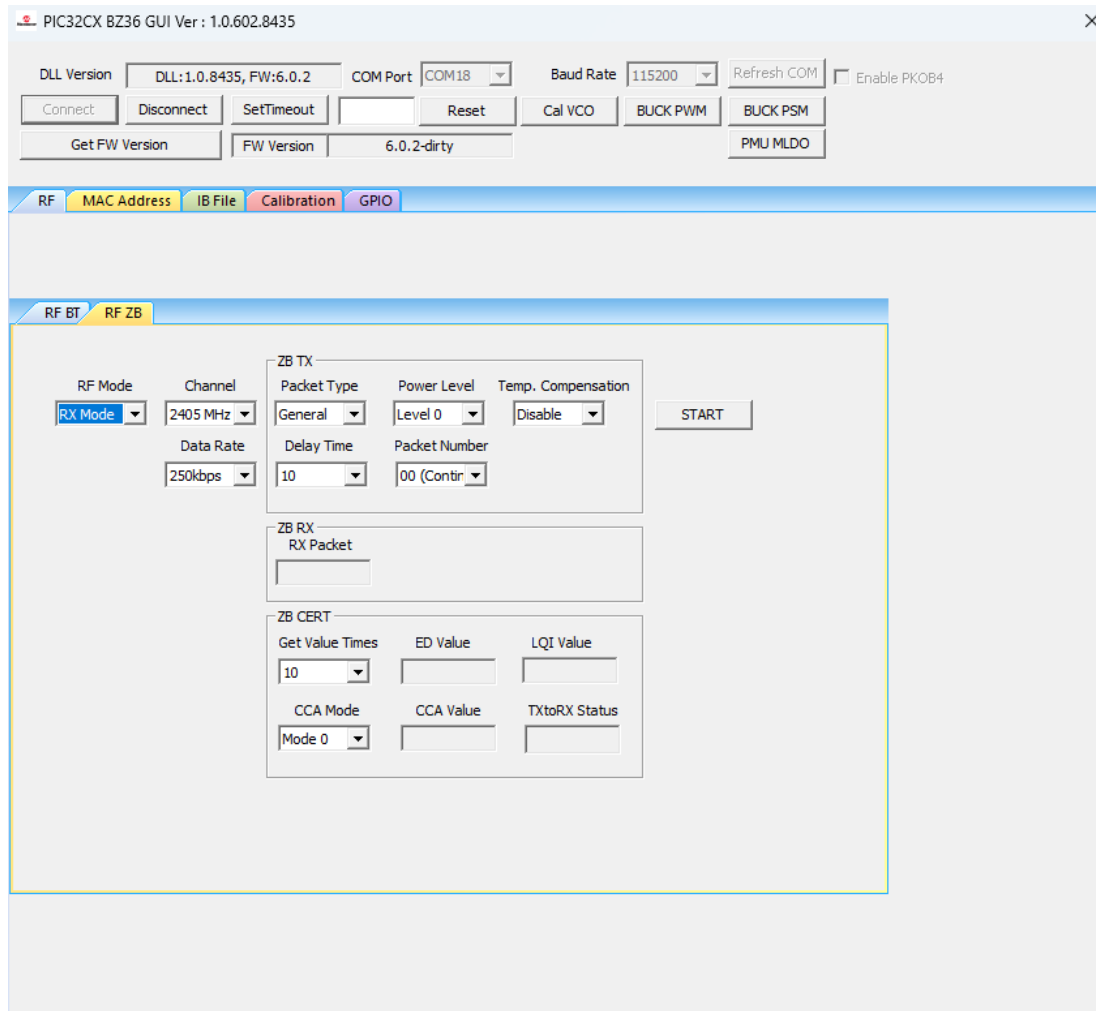

Perform the following steps for the demonstration of the Zigbee CW mode to transmit CW tone:

1. Set up the connection between the PIC32CX-BZ36 Curiosity Board and PC. For more details, refer to [Getting Started with MCHPRT3](#).
2. In the **RF ZB** tab, perform the following steps:
 - a. From the “RF mode” drop-down list, select *CW Mode*.
 - b. From the “Channel” drop-down list, select *2405 MHz* for channel 11.
 - c. From the “Power Level” drop-down list, select *Disable* (the maximum power level is the default value).
3. Click **START** to transmit the CW tone.

Figure 4-14. MCHPRT3 PIC32CX-BZ36 GUI for Zigbee CW Mode Demonstration

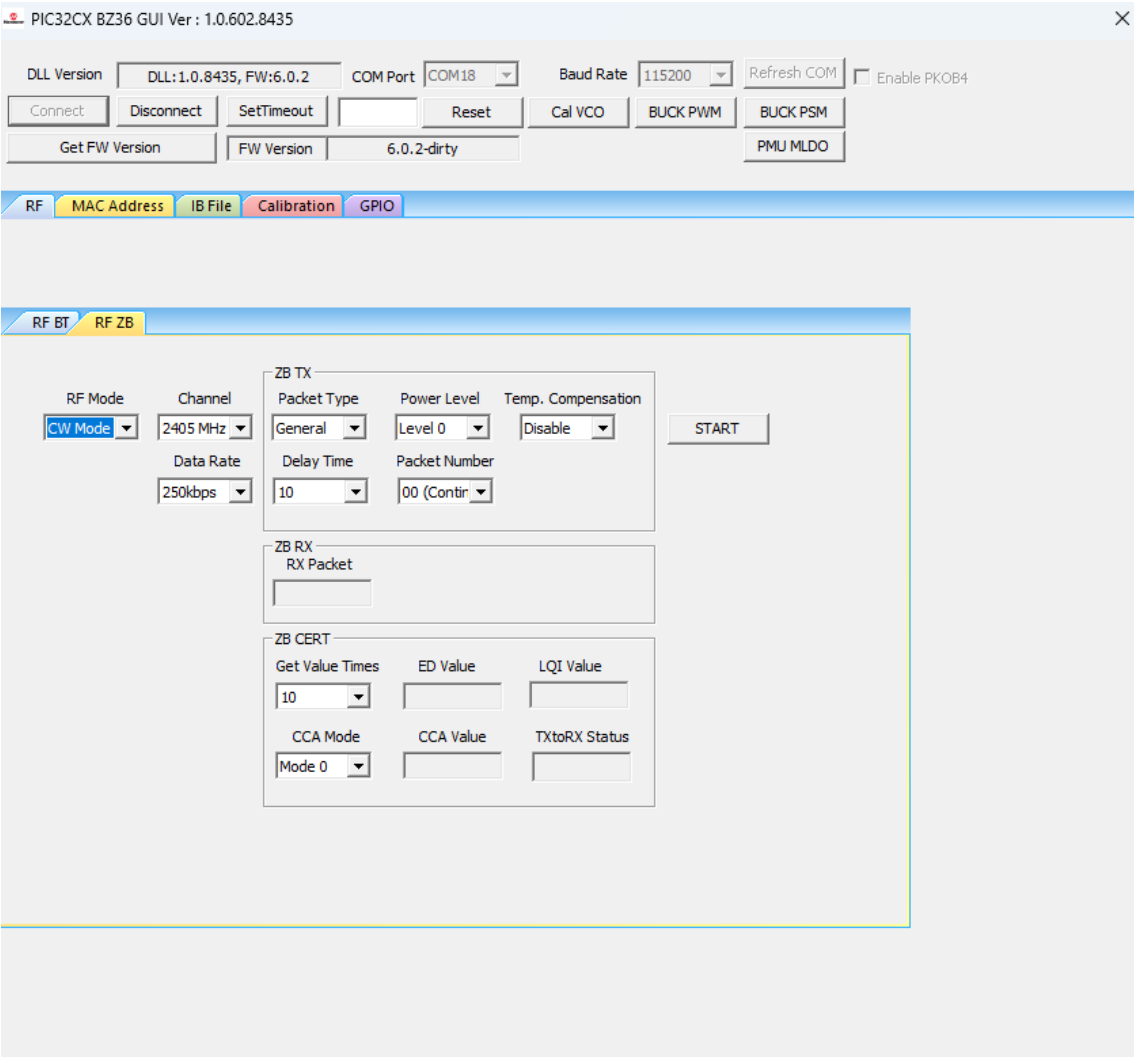

ED mode, LQI mode, CCA mode, TX to RX mode and RX to TX mode, as well as the area of **ZB CERT** are used in Zigbee PHY certification.

Figure 4-15. MCHPRT3 PIC32CX-BZ36 GUI for Zigbee PHY Test

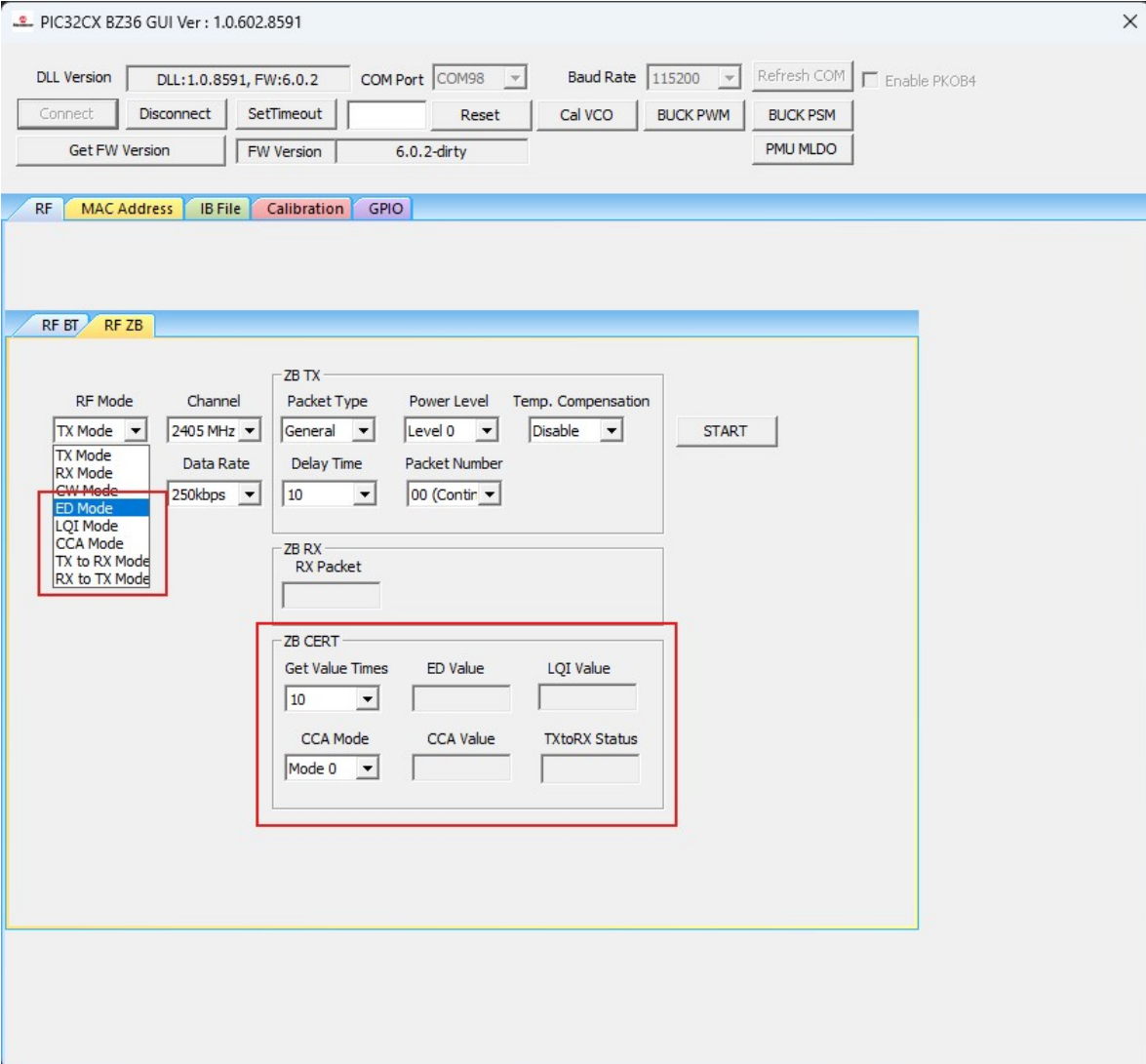

4.3.3. Calibration Flow Demonstration

In this demonstration, the user can calibrate TX parameters and RX parameters of the PIC32CX-BZ36 using a PC with the installed MCHPRT3 tool. The calibration step could be checked in the “Cal. Flow Status” in the Calibration page.

Perform the following steps for the demonstration of the calibration flow (see the following figure):

1. Set up the connection between the PIC32CX-BZ36 Curiosity Board and PC. For more details, refer to [Getting Started with MCHPRT3](#).
2. Connect the u.FL connector on the PIC32CX-BZ36 to the Bluetooth/Zigbee tester (IQxel or others) to measure the RF power from the PIC32CX-BZ36.
3. Check the cable loss between the PIC32CX-BZ36 u.FL connector to the Bluetooth/Zigbee tester.
4. MLDO is the preferred mode of calibration. Click **PMU MLDO** to use the MLDO mode to perform calibration.



OTP is limited in memory of 4k, and it can only be calibrated 10 to 15 times.

5. Click **Start Cal.** to start the new calibration.
6. Click **Freq. Start** in Cal. step 1. Freq., the DUT transmits the Bluetooth Low Energy packet at 2440 MHz.
7. Check the carrier frequency at the tester, then click **Freq. decrease** or **Freq. increase** to change the carrier frequency.
8. Once the carrier frequency is close to 2440 MHz, click **Freq. Done**.
9. Click **IQ Cal. Start** in Cal. step 4. RX IQ.
10. Generate 2424 MHz CW tone from the test equipment at -50 dBm including cable loss by using the tester, then feed it into DUT and click **IQ -50 Tune**.
11. Generate 2426 MHz CW tone from the test equipment at -50 dBm including cable loss by using the tester, then click **IQ Main Tune**.
12. Repeat steps 11 if required by MCHPRT3, clicking **IQ -40 Tune** with generating 2424 MHz CW tone at -40 dBm by using the tester and clicking **IQ -30 Tune** with generating 2424 MHz CW tone at -30 dBm by using the tester.
13. Click **IQ Cal. Done**.
14. Click **TX P1 Start** in Cal. step 5. RF TX, enter the power level shown in the tester with the cable loss, then click **TX P1 Tune**.
15. Click **TX P2 Start** in Cal. step 5. RF TX, enter the power level shown in the tester with the cable loss, then click **TX P2 Tune**.
16. Click **TX P3 Start** in Cal. step 5. RF TX, enter the power level shown in the tester with the cable loss, then click **TX P3 Tune**.
17. Click **TX P4 Start** in Cal. step 5. RF TX, enter the power level shown in the tester with the cable loss, then click **TX P4 Tune**.
18. Click **TX P5 Start** in Cal. step 5. RF TX, enter the power level shown in the tester with the cable loss, then click **TX P5 Tune**.
19. Click **TX P6 Start** in Cal. step 5. RF TX, enter the power level shown in the tester with the cable loss, then click **TX P6 Tune**.
20. Click **ED Cal. Init.**, generate 2440 MHz CW tone at -70 dBm including cable loss by using the tester **ED Cal. Trim** in Cal. step 6. ED.

21. Click **ED Cal. Done**.
22. Click **Save Cal. Data** in Cal. step 7. Save data to save the calibration data into the file and the DUT.

Figure 4-16. MCHPRT3 PIC32CX-BZ36 GUI for Calibration Flow Demonstration

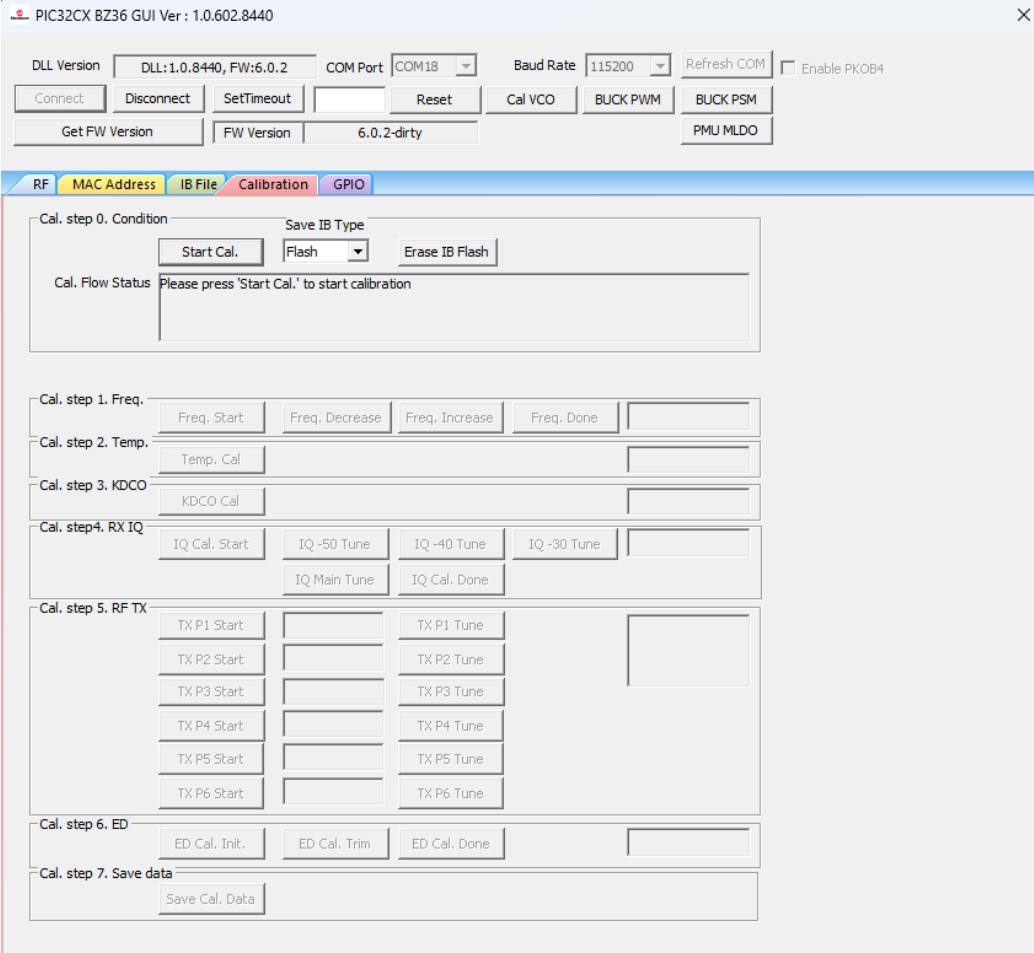
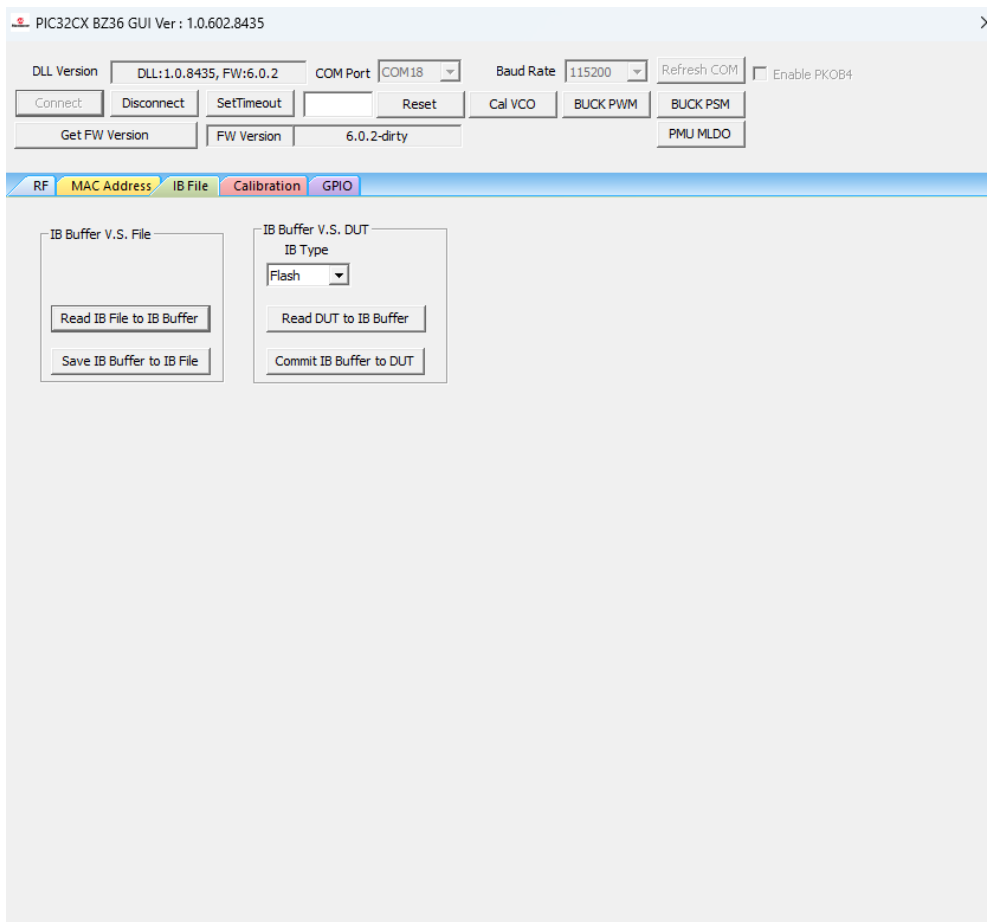

Figure 4-17. Calibration Setup



4.3.4. Operation on IB (Information Block) File

Figure 4-18. MCHPRT3 PIC32CX-BZ36 GUI for IB (Information Block) File Operation



The user can perform the following in the **IB File** tab:

- Read the IB⁽¹⁾ File to IB Buffer⁽²⁾.
- Save IB Buffer into the IB File.
- From the “IB Type” drop-down list, select *Flash* (default value).
- Read the IB from DUT into the IB Buffer.
- Commit the IB Buffer into DUT – the IB is stored in the Flash.

Note:

1. Use the Information Block (IB) to store various types of calibration and system configuration information.
2. The IB Buffer is a temporary PC location for the Information Block (IB).

4.3.5. MAC Address Programming

In this demonstration, the user can set the Bluetooth Address and Zigbee MAC Address of the PIC32CX-BZ36 using a PC with the MCHPRT3 tool installed.

In the **MAC Address** tab, perform the following steps for MAC Address programming:

1. From the **IB Type** drop-down list, select *Flash* (default value).

2. To read the Bluetooth address from the IB, click **Read BT Addr from IB**.
3. To write the Bluetooth address:
 - a. Click **Write BT Addr to IB Buffer**.
 - b. Click **Commit BT Addr IB Buffer to IB**.
4. To read the Zigbee MAC address from IB, click **Read ZB Addr from IB**.
5. To write Zigbee MC address:
 - a. Click **Write ZB Addr to IB Buffer**.
 - b. Click **Commit ZB Addr IB Buffer to IB**.

Figure 4-19. MCHPRT3 PIC32CX-BZ36 GUI for MAC Address Programming

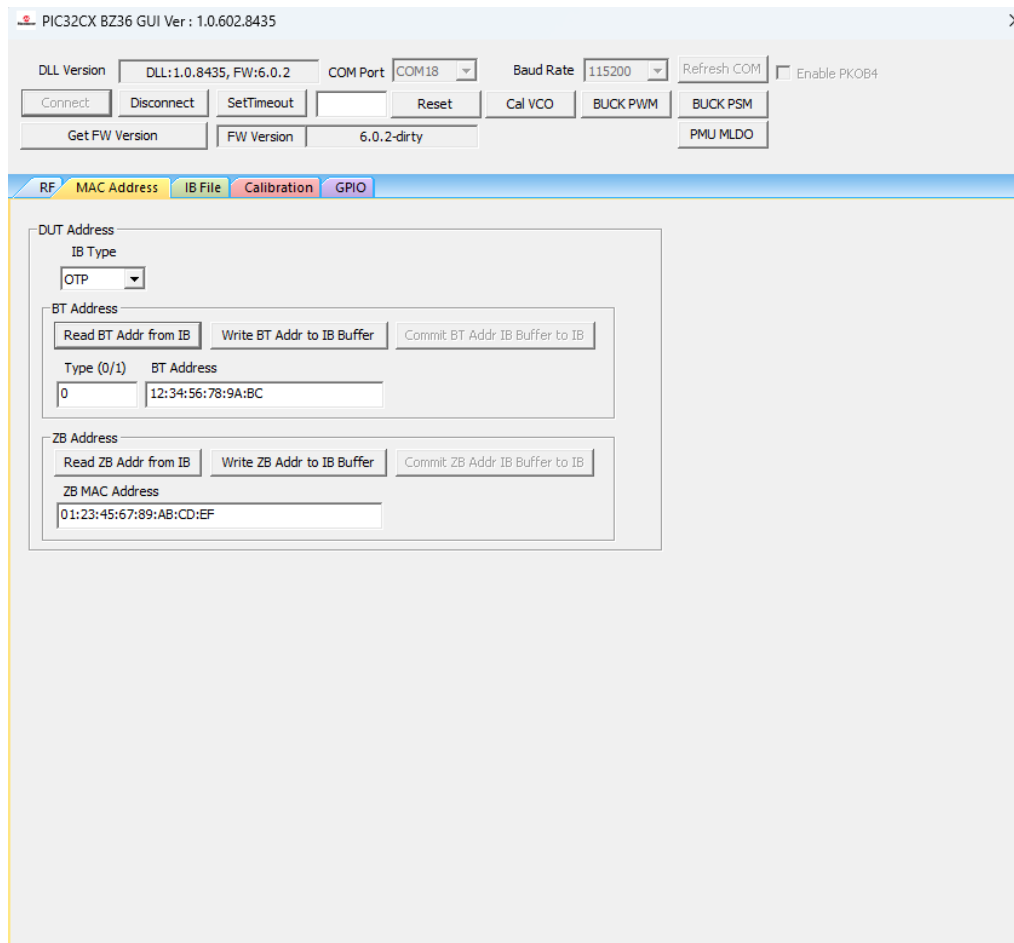

4.3.6. GPIO Demonstration

In this demonstration, the user can configure or test the GPIO of the PIC32CX-BZ36 using a PC with the installed MCHPRT3 tool.

In the **GPIO** tab, perform the following steps for the GPIO demonstration (see the following figure):

1. Click **Start GPIO Test** to initiate the GPIO settings for configuration or test.
2. Select *Port*, *Pin*, *In/Out* and *Level* to configure or test the GPIO pins.
3. Click **Run** to apply the GPIO configuration.
4. Repeat step 2 and 3 to perform a new GPIO configuration or test.

- 5. Click **Stop GPIO Test** to stop the GPIO settings for configuration or test.
- 6. Check the checkbox on each item to perform multiple GPIO configurations. Click **Run All Select GPIO** to apply all the selected GPIO configuration.

Figure 4-20. MCHPRT3 PIC32CX-BZ36 GUI GPIO Demonstration

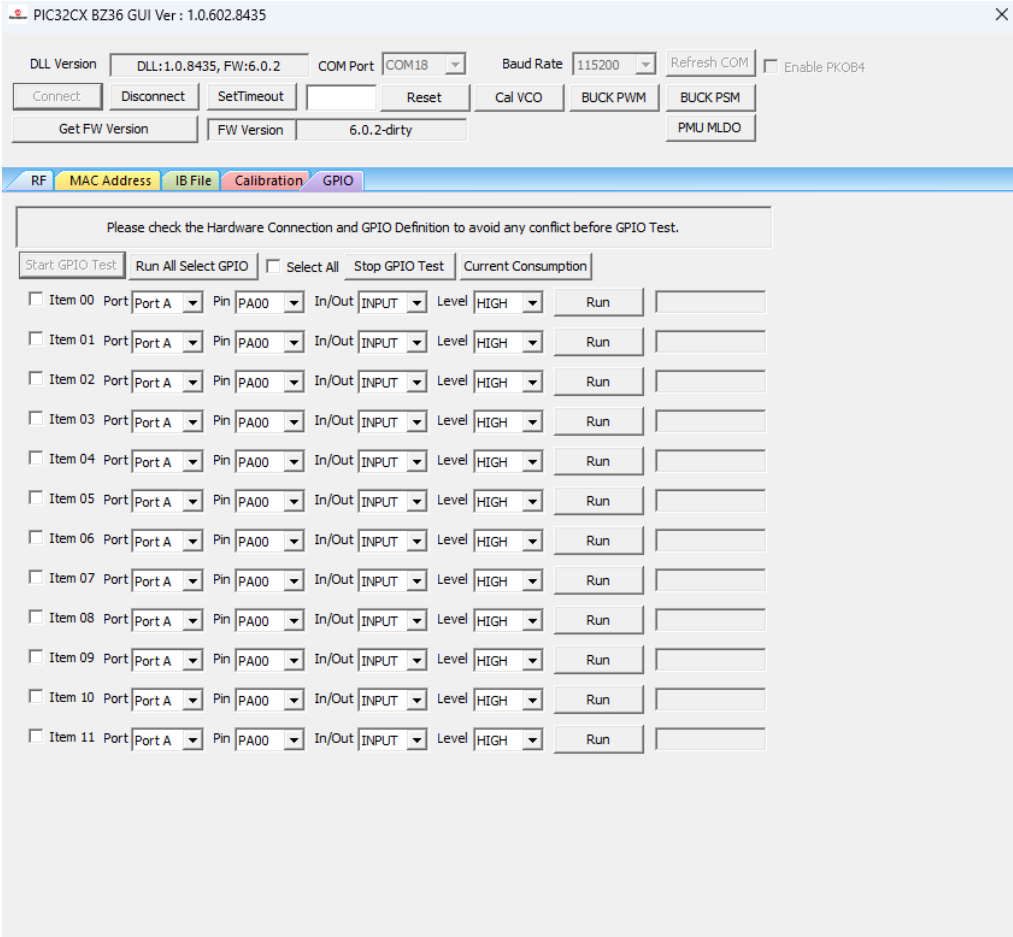

5. Document Revision History

The revision history describes the changes that were implemented in the document. The changes are listed by revision, starting with the most current publication.

Revision	Date	Section	Description
A	12/2025	Document	Initial revision

Microchip Information

Trademarks

The “Microchip” name and logo, the “M” logo, and other names, logos, and brands are registered and unregistered trademarks of Microchip Technology Incorporated or its affiliates and/or subsidiaries in the United States and/or other countries (“Microchip Trademarks”). Information regarding Microchip Trademarks can be found at <https://www.microchip.com/en-us/about/legal-information/microchip-trademarks>.

ISBN: 979-8-3371-2559-6

Legal Notice

This publication and the information herein may be used only with Microchip products, including to design, test, and integrate Microchip products with your application. Use of this information in any other manner violates these terms. Information regarding device applications is provided only for your convenience and may be superseded by updates. It is your responsibility to ensure that your application meets with your specifications. Contact your local Microchip sales office for additional support or, obtain additional support at www.microchip.com/en-us/support/design-help/client-support-services.

THIS INFORMATION IS PROVIDED BY MICROCHIP “AS IS”. MICROCHIP MAKES NO REPRESENTATIONS OR WARRANTIES OF ANY KIND WHETHER EXPRESS OR IMPLIED, WRITTEN OR ORAL, STATUTORY OR OTHERWISE, RELATED TO THE INFORMATION INCLUDING BUT NOT LIMITED TO ANY IMPLIED WARRANTIES OF NON-INFRINGEMENT, MERCHANTABILITY, AND FITNESS FOR A PARTICULAR PURPOSE, OR WARRANTIES RELATED TO ITS CONDITION, QUALITY, OR PERFORMANCE.

IN NO EVENT WILL MICROCHIP BE LIABLE FOR ANY INDIRECT, SPECIAL, PUNITIVE, INCIDENTAL, OR CONSEQUENTIAL LOSS, DAMAGE, COST, OR EXPENSE OF ANY KIND WHATSOEVER RELATED TO THE INFORMATION OR ITS USE, HOWEVER CAUSED, EVEN IF MICROCHIP HAS BEEN ADVISED OF THE POSSIBILITY OR THE DAMAGES ARE FORESEEABLE. TO THE FULLEST EXTENT ALLOWED BY LAW, MICROCHIP’S TOTAL LIABILITY ON ALL CLAIMS IN ANY WAY RELATED TO THE INFORMATION OR ITS USE WILL NOT EXCEED THE AMOUNT OF FEES, IF ANY, THAT YOU HAVE PAID DIRECTLY TO MICROCHIP FOR THE INFORMATION.

Use of Microchip devices in life support and/or safety applications is entirely at the buyer’s risk, and the buyer agrees to defend, indemnify and hold harmless Microchip from any and all damages, claims, suits, or expenses resulting from such use. No licenses are conveyed, implicitly or otherwise, under any Microchip intellectual property rights unless otherwise stated.

Microchip Devices Code Protection Feature

Note the following details of the code protection feature on Microchip products:

- Microchip products meet the specifications contained in their particular Microchip Data Sheet.
- Microchip believes that its family of products is secure when used in the intended manner, within operating specifications, and under normal conditions.
- Microchip values and aggressively protects its intellectual property rights. Attempts to breach the code protection features of Microchip products are strictly prohibited and may violate the Digital Millennium Copyright Act.
- Neither Microchip nor any other semiconductor manufacturer can guarantee the security of its code. Code protection does not mean that we are guaranteeing the product is “unbreakable”. Code protection is constantly evolving. Microchip is committed to continuously improving the code protection features of our products.