



Crypto Library Help

MPLAB Harmony Integrated Software Framework

Volume V: MPLAB Harmony Framework Reference

This volume provides API reference information for the framework libraries included in your installation of MPLAB Harmony.

Description



This volume is a programmer reference that details the interfaces to the libraries that comprise MPLAB Harmony and explains how to use the libraries individually to accomplish the tasks for which they were designed.

Crypto Library Help

This section describes the Cryptographic (Crypto) Library that is available in MPLAB Harmony.

Introduction

This library provides a software Cryptographic Library that is available on the Microchip family of microcontrollers with a convenient C language interface.

Description

The Cryptographic Library includes functions to perform encryption, decryption, hashing, authentication, and compression within the embedded application. Random number generation (RNG) functions are also provided.

Block Ciphers

The library provides DES, 3DES, and AES for block cipher needs. Depending on the algorithm in use, CBC and CTR modes are supported.

Public Key Cryptography

The library provides RSA and Elliptic Curve Cryptography (ECC) for Public Key Cryptography, and Diffie-Hellman (DH) for key agreement arrangements.

Hash Functions

The library provides MD5, SHA, SHA-256, SHA-384, and SHA-512 for hashing. These functions do not require keys or initialization vectors (IV).

Random Number Generation Functions

The library provides functions to generate either a single pseudo-random number, or a block of such numbers.

Using the Library

This topic describes the basic architecture of the Cryptographic (Crypto) Library and provides information and examples on its use.

Description

Interface Header File: [crypto.h](#)

The interface to the Crypto Library is defined in the [crypto.h](#) header file. Any C language source (.c) file that uses the Crypto Library should include [crypto.h](#).

Library File:

The Crypto Library archive (.a) file is installed with MPLAB Harmony.

Please refer to the [What is MPLAB Harmony?](#) section for how the Crypto Library interacts with the framework.

Abstraction Model

This library provides the low-level abstraction of the Cryptographic Library module on the Microchip family of microcontrollers with a convenient C language interface. This topic describes how that abstraction is modeled in the software and introduces the library interface.

Description

Cryptographic (Crypto) Software Abstraction Block Diagram

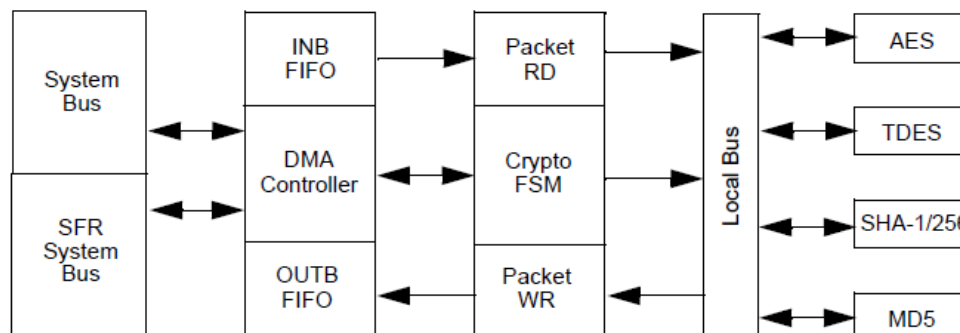

Library Overview

The [Library Interface](#) routines are divided into various sub-sections, which address one of the blocks or the overall operation of the Cryptographic (Crypto) Library module.

Library Interface Section	Description
General Functions	Provides an error string function, which takes an error and converts it into human-readable text.
Compression Functions	Provides Huffman compression and decompression functions.
MD5 Functions	Provides data add, finalize, and initialize MD5 functions.
Random Number Generator Functions	Provides get, initialize, and block generate RNG functions.
AES Encryption/Decryption Functions	Provides AES encryption and decryption functions.
ECC Encryption/Decryption Functions	Provides ECC encryption and decryption functions.
RSA Encryption/Decryption Functions	Provides RSA encryption and decryption functions.
Triple DES Encryption/Decryption Functions	Provides 3DES encryption and decryption functions.
HMAC Hash Functions	Provides HMAC data add, finalize, and set key Hash functions.
SHA Hash Functions	Provides SHA data add, finalize, and initialize Hash functions.
SHA256 Hash Functions	Provides SHA256 data add, finalize, and initialize Hash functions.
SHA384 Hash Functions	Provides SHA384 data add, finalize, and initialize Hash functions.
SHA512 Hash Functions	Provides SHA512 data add, finalize, and initialize Hash functions.

Configuring the Library

The configuration of the Cryptographic Library is based on the file `system_config.h`.

This header file contains the configuration selection for the Cryptographic Library. Based on the selections made, the Cryptographic Library may support the selected features. These configuration settings will apply to all instances of the Cryptographic Library.

This header can be placed anywhere; however, the path of this header needs to be present in the include search path for a successful build. Refer to the Applications Help section for more details.

Building the Library

This section lists the files that are available in the Crypto Library.

Description

The following three tables list and describe the header (.h) and source (.c) files that implement this library. The parent folder for these files is `<install-dir>/framework/crypto`.

Interface File(s)

This table lists and describes the header files that must be included (i.e., using `#include`) by any code that uses this library.

Source File Name	Description
crypto.h	Includes all MPLAB Harmony-compatible function calls for the Crypto Library.

Required File(s)



All of the required files listed in the following table are automatically added into the MPLAB X IDE project by the MHC when the library is selected for use.

This table lists and describes the source and header files that must *always* be included in the MPLAB X IDE project to build this library.

Source File Name	Description
<install-dir>/build/framework/crypto/crypto.X	<p>Include this project to bring in the library and all associated functions. There are two build configuration options available for this library:</p> <ul style="list-style-type: none"> SW – Software-only configuration for all Microchip PIC32 microcontrollers. HW – Hardware acceleration configuration for PIC32 devices that have a hardware encryption module <p>For both configurations, adjust the properties if 16-bit code is desired, and set the appropriate version of microcontroller.</p>

Optional File(s)

This table lists and describes the source and header files that may optionally be included if required for the desired implementation.



Source File Name	Description
<install-dir>/build/framework/crypto/zlib.X	<p>This project provides the code for Huffman compression in the Crypto Library. If the application does not use Huffman compression, this library may be excluded.</p> <p>There are two build configuration options available for this library:</p> <ul style="list-style-type: none"> PIC32MX – for PIC32MX devices PIC32MZ – for PIC32MZ devices <p>For both configurations, adjust the properties if 16-bit code is desired.</p>

Module Dependencies



The Crypto Library does not depend on any other modules.

Library Interface





a) General Functions

	Name	Description
	CRYPT_RNG_Initialize	Initializes the random number generator.
	CRYPT_ERROR_StringGet	Reports the nature of an error.



b) Compression Functions

	Name	Description
	CRYPT_HUFFMAN_Compress	Compresses a block of data.
	CRYPT_HUFFMAN_DeCompress	Decompresses a block of data.







c) MD5 Functions

	Name	Description
	CRYPT_MD5_DataAdd	Updates the hash with the data provided.
	CRYPT_MD5_Finalize	Finalizes the hash and puts the result into digest.
	CRYPT_MD5_Initialize	Initializes the internal structures necessary for MD5 hash calculations.
	CRYPT_MD5_DataSizeSet	For PIC32MZ hardware encryption, sets the size of the input data.

d) Random Number Generator Functions











	Name	Description
	CRYPT_RNG_BlockGenerate	Creates several random numbers.
	CRYPT_RNG_Get	Gets one random number.

e) AES Encryption/Decryption Functions







	Name	Description
	CRYPT_AES_CBC_Decrypt	Performs AES decryption using Cipher-Block-Chaining (CBC).
	CRYPT_AES_CBC_Encrypt	Performs AES encryption using Cipher-Block-Chaining (CBC).
	CRYPT_AES_CTR_Encrypt	Performs AES encryption using Counter (CTR).
	CRYPT_AES_DIRECT_Decrypt	Directs decryption of one block of data.
	CRYPT_AES_DIRECT_Encrypt	Directs encryption of one block of data.
	CRYPT_AES_IvSet	Sets the initialization vector (IV) for AES processing.

	CRYPT_AES_KeySet	Sets the key and initialization vector (IV) for AES processing.
---	----------------------------------	---





f) ECC Encryption/Decryption Functions

	Name	Description
	CRYPT_ECC_DHE_KeyMake	Creates a new ECC key.
	CRYPT_ECC_DHE_SharedSecretMake	Creates an ECC shared secret between two keys.
	CRYPT_ECC_DSA_HashSign	Signs a message digest.
	CRYPT_ECC_DSA_HashVerify	Verifies an ECC signature.
	CRYPT_ECC_Free	Cleans up an Elliptic Curve Cryptography (ECC) Context.
	CRYPT_ECC_Initialize	Initializes the context for Elliptic Curve Cryptography (ECC).
	CRYPT_ECC_KeySizeGet	Returns the key size in octets.
	CRYPT_ECC_PrivateImport	Imports private key pair in X9.63 format.
	CRYPT_ECC_PublicExport	Exports public ECC key in ANSI X9.63 format.
	CRYPT_ECC_PublicImport	Imports public key in ANSI X9.63 format.
	CRYPT_ECC_SignatureSizeGet	Returns the signature size in octets.



g) RSA Encryption/Decryption Functions

	Name	Description
	CRYPT_RSA_EncryptSizeGet	Gets the size of the RSA Key.
	CRYPT_RSA_Free	Releases the memory used for the key and clean up the context.
	CRYPT_RSA_Initialize	Initializes the internal structures necessary for RSA processing.
	CRYPT_RSA_PrivateDecrypt	Decrypts data using a private key.
	CRYPT_RSA_PrivateKeyDecode	Constructs the Private Key from a DER certificate.
	CRYPT_RSA_PublicEncrypt	Encrypts data using a public key.
	CRYPT_RSA_PublicKeyDecode	Constructs the Public Key from a DER certificate.





h) Triple DES (3DES) Encryption/Decryption Functions

	Name	Description
	CRYPT_TDES_CBC_Decrypt	Decrypts a data block using Triple DES.
	CRYPT_TDES_CBC_Encrypt	Encrypts a data block using Triple DES.
	CRYPT_TDES_IvSet	Sets the Initialization Vector (IV) for a Triple DES operation.
	CRYPT_TDES_KeySet	Initialization of Triple DES context.





i) HMAC Hash Functions

	Name	Description
	CRYPT_HMAC_DataAdd	Adds data to the HMAC calculation.
	CRYPT_HMAC_Finalize	Completes the HMAC calculation and get the results.
	CRYPT_HMAC_SetKey	Initializes the HMAC context and set the key for the hash.

j) SHA Hash functions



	Name	Description
	CRYPT_SHA_DataAdd	Updates the hash with the data provided.
	CRYPT_SHA_Finalize	Finalizes the hash and puts the result into digest.
	CRYPT_SHA_Initialize	Initializes the internal structures necessary for SHA hash calculations.
	CRYPT_SHA_DataSizeSet	For PIC32MZ hardware encryption, sets the size of the input data.

k) SHA256 Hash Functions



	Name	Description
	CRYPT_SHA256_DataAdd	Updates the hash with the data provided.
	CRYPT_SHA256_Finalize	Finalizes the hash and puts the result into digest.
	CRYPT_SHA256_Initialize	Initializes the internal structures necessary for SHA256 hash calculations.
	CRYPT_SHA256_DataSizeSet	For PIC32MZ hardware encryption, sets the size of the input data.

l) SHA384 Hash Functions











	Name	Description
	CRYPT_SHA384_DataAdd	Updates the hash with the data provided.

	CRYPT_SHA384_Finalize	Finalizes the hash and puts the result into digest.
	CRYPT_SHA384_Initialize	Initializes the internal structures necessary for SHA384 hash calculations.

m) SHA512 Hash Functions

	Name	Description
	CRYPT_SHA512_DataAdd	Updates the hash with the data provided.
	CRYPT_SHA512_Finalize	Finalizes the hash and puts the result into digest.
	CRYPT_SHA512_Initialize	Initializes the internal structures necessary for SHA512 hash calculations.

n) Data Types and Constants

	Name	Description
	CRYPT_AES_CTX	AES
	CRYPT_ECC_CTX	ECC
	CRYPT_HMAC_CTX	HMAC
	CRYPT_MD5_CTX	MD5
	CRYPT_RNG_CTX	RNG
	CRYPT_RSA_CTX	RSA
	CRYPT_SHA_CTX	SHA
	CRYPT_SHA256_CTX	SHA-256
	CRYPT_SHA384_CTX	SHA-384
	CRYPT_SHA512_CTX	SHA-512
	CRYPT_TDES_CTX	TDES
	MC_CRYPT_API_H	Defines Microchip CRYPTO API layer

Description

This section describes the Application Programming Interface (API) functions of the Cryptographic Library. Refer to each section for a detailed description.

a) General Functions

CRYPT_RNG_Initialize Function

Initializes the random number generator.

File

[crypto.h](#)

C

```
int CRYPT_RNG_Initialize(CRYPT_RNG_CTX*);
```

Returns

- negative - An error occurred setting up the random number generator.
- 0 - An invalid pointer was not passed to the function.

Description

This function initializes the context that stores information relative to random number generation.

Preconditions

None.

Example

```
#define RANDOM_BYTE_SZ 32

int          ret;
CRYPT_RNG_CTX mcRng;
byte        out[RANDOM_BYTE_SZ];

ret = CRYPT_RNG_Initialize(&mcRng);
```

```
ret = CRYPT_RNG_Get(&mcRng, &out[0]);

ret = CRYPT_RNG_BlockGenerate(&mcRng, out, RANDOM_BYTE_SZ);
```

Parameters

Parameters	Description
rng	Pointer to random number generator context.

Function

```
int CRYPT_RNG_Initialize( CRYPT_RNG_CTX* rng)
```

CRYPT_ERROR_StringGet Function

Reports the nature of an error.

File

[crypto.h](#)

C

```
int CRYPT_ERROR_StringGet(int, char*);
```

Returns

- BAD_FUNC_ARG - A null string was passed for the return message.
- 0 - A null string was not passed for the return message.

Description

This function takes an error and converts it into human-readable text.

Remarks

String needs to be >= 80 chars.

Preconditions

None.

Example

```
char msg[80];

CRYPT_ERR_StringGet(ret, msg);
```

Parameters

Parameters	Description
int	Error code to convert.
str	Pointer to buffer to store the message. Must hold at least 80 characters.

Function

```
int CRYPT_ERROR_StringGet(int err, char* str)
```

b) Compression Functions

CRYPT_HUFFMAN_Compress Function

Compresses a block of data.

File

[crypto.h](#)

C

```
int CRYPT_HUFFMAN_Compress(unsigned char*, unsigned int, const unsigned char*, unsigned int, unsigned int);
```

Returns

- negative - error code
- positive - bytes stored in out buffer

Description

This function compresses a block of data using Huffman encoding.

Remarks

Output buffer must be large enough to hold the contents of the operation.

Preconditions

None.

Example

```
const unsigned char text[] = "...";
unsigned int inSz = sizeof(text);
unsigned int outSz;
unsigned char cBuffer[1024];

int ret;

ret = CRYPT_HUFFMAN_COMPRESS(cBuffer, sizeof(cBuffer), text, inSz, 0);
```

Parameters

Parameters	Description
out	Pointer to location to store the compressed data.
outSz	Maximum size of the output data in bytes.
in	Point to location of source data.
inSz	Size of the input data in bytes.
flags	Flags to control how compress operates

Function

```
int CRYPT_HUFFMAN_Compress(unsigned char* out, unsigned int outSz, const unsigned char* in,
unsigned int inSz, unsigned int flags)
```

CRYPT_HUFFMAN_DeCompress Function

Decompresses a block of data.

File

[crypto.h](#)

C

```
int CRYPT_HUFFMAN_DeCompress(unsigned char*, unsigned int, const unsigned char*, unsigned int);
```

Returns

- negative - Error code
- positive - Bytes stored in out buffer

Description

This function decompresses a block of data using Huffman encoding.

Remarks

Output buffer must be large enough to hold the contents of the operation.

Preconditions

None.

Example

```
unsigned char cBuffer[1024];
unsigned char dBuffer[1024];
```

```
int ret

ret = CRYPT_HUFFMAN_DeCompress(dBuffer, sizeof(dBuffer), cBuffer, msglen);
```

Parameters

Parameters	Description
out	Pointer to destination buffer
outSz	Size of destination buffer
in	Pointer to source buffer to decompress
inSz	Size of source buffer to decompress

Function

```
int CRYPT_HUFFMAN_DeCompress(unsigned char* out, unsigned int outSz, const unsigned char* in, unsigned int inSz)
```

c) MD5 Functions

CRYPT_MD5_DataAdd Function

Updates the hash with the data provided.

File

crypto.h

C

```
int CRYPT_MD5_DataAdd(CRYPT_MD5_CTX*, const unsigned char*, unsigned int);
```

Returns

- BAD_FUNC_ARG - An invalid pointer was passed to the function, either in md5 or input
- 0 - An invalid pointer was not passed to the function

Description

This function updates the hash with the data provided.

Remarks

To preserve the validity of the MD5 hash, nothing must modify the context holding variable between calls to CRYPT_MD5_DataAdd.

Preconditions

The MD5 context must be initialized prior to the first call of this function. The context must not be modified by code outside of this function.

Example

```
CRYPT_MD5_CTX md5;
uint8_t buffer[1024];
uint8_t md5sum[MD5_DIGEST_SIZE];

CRYPT_MD5_Initialize(&md5);
CRYPT_MD5_DataAdd(&md5, buffer, sizeof(buffer));
CRYPT_MD5_Finalize(&md5, md5sum);
```

Parameters

Parameters	Description
md5	Pointer to CRYPT_MD5_CTX structure which holds the hash values.
sz	Size of the data (in bytes) of the data to use to update the hash.

Function

```
int CRYPT_MD5_DataAdd( CRYPT_MD5_CTX* md5, const unsigned char* input, unsigned int sz)
```

CRYPT_MD5_Finalize Function

Finalizes the hash and puts the result into digest.

File

[crypto.h](#)

C

```
int CRYPT_MD5_Finalize(CRYPT_MD5_CTX*, unsigned char*);
```

Returns

- BAD_FUNC_ARG - An invalid pointer was passed to the function, either in md5 or digest.
- 0 - An invalid pointer was not passed to the function.

Description

This function finalizes the hash and puts the result into digest.

Remarks

In order to preserve the validity of the MD5 hash, nothing must modify the context holding variable between calls to [CRYPT_MD5_DataAdd](#) and [CRYPT_MD5_Finalize](#).

Preconditions

The MD5 context must be initialized prior to calling this function. The context must not be modified by code outside of this function.

Example

```
CRYPT_MD5_CTX md5;
uint8_t buffer[1024];
uint8_t md5sum[MD5_DIGEST_SIZE];

CRYPT_MD5_Initialize(&md5);
CRYPT_MD5_DataAdd(&md5, buffer, sizeof(buffer));
CRYPT_MD5_Finalize(&md5, md5sum);
```

Parameters

Parameters	Description
md5	Pointer to CRYPT_MD5_CTX structure which holds the hash values.
digest	Pointer to byte array to store hash result.

Function

```
int CRYPT_MD5_Finalize( CRYPT_MD5_CTX* md5, unsigned char* digest)
```

CRYPT_MD5_Initialize Function

Initializes the internal structures necessary for MD5 hash calculations.

File

[crypto.h](#)

C

```
int CRYPT_MD5_Initialize(CRYPT_MD5_CTX*);
```

Returns

- BAD_FUNC_ARG - An invalid pointer was passed to the function.
- 0 - An invalid pointer was not passed to the function.

Description

This function initializes the internal structures necessary for MD5 hash calculations.

Remarks

All MD5 hashes have to start at a particular value before adding new data to it. This function sets the necessary values for the structure.

Preconditions

None.

Example

```
CRYPT_MD5_CTX md5;
uint8_t buffer[1024];
uint8_t md5sum[MD5_DIGEST_SIZE];

CRYPT_MD5_Initialize(&md5);
CRYPT_MD5_DataAdd(&md5, buffer, sizeof(buffer));
CRYPT_MD5_Finalize(&md5, md5sum);
```

Parameters

Parameters	Description
md5	Pointer to CRYPT_MD5_CTX structure which holds the hash values.

Function

```
int CRYPT_MD5_Initialize( CRYPT_MD5_CTX* md5)
```

CRYPT_MD5_DataSizeSet Function

For PIC32MZ hardware encryption, sets the size of the input data.

File

[crypto.h](#)

C

```
int CRYPT_MD5_DataSizeSet(CRYPT_MD5_CTX*, unsigned int);
```

Returns

- BAD_FUNC_ARG - An invalid pointer was passed to the function.
- 0 - An invalid pointer was not passed to the function.

Description

The PIC32MZ hardware encryption module needs to know the size of the data before it starts processing. This function sets that value.

Remarks

All MD5 hashes have to start at a particular value before adding new data to it. This function sets the necessary values for the structure.

Preconditions

None.

Example

```
CRYPT_MD5_CTX md5;
uint8_t buffer[1024];
uint8_t md5sum[MD5_DIGEST_SIZE];

CRYPT_MD5_Initialize(&md5);
CRYPT_MD5DataSizeSet(&md5, sizeof(buffer));
CRYPT_MD5_DataAdd(&md5, buffer, sizeof(buffer));
CRYPT_MD5_Finalize(&md5, md5sum);
```

Parameters

Parameters	Description
md5	Pointer to CRYPT_MD5_CTX structure which holds the hash values.
msgSize	Size of the data (in bytes) that will be processed.

Function

```
int CRYPT_MD5_DataSizeSet( CRYPT_MD5_CTX* md5, unsigned int msgSize)
```

d) Random Number Generator Functions

CRYPT_RNG_BlockGenerate Function

Create several random numbers.

File

[crypto.h](#)

C

```
int CRYPT_RNG_BlockGenerate(CRYPT_RNG_CTX*, unsigned char*, unsigned int);
```

Returns

- BAD_FUNC_ARG - An invalid pointer was passed to the function.
- 0 - An invalid pointer was not passed to the function.

Description

This function generates several random numbers and places them in the space allocated.

Preconditions

RNG context was initialized using the [CRYPT_RNG_Initialize](#) function.

Example

```
#define RANDOM_BYTE_SZ 32

int          ret;
CRYPT_RNG_CTX mcRng;
byte        out[RANDOM_BYTE_SZ];

ret = CRYPT_RNG_Initialize(&mcRng);

ret = CRYPT_RNG_Get(&mcRng, &out[0]);

ret = CRYPT_RNG_BlockGenerate(&mcRng, out, RANDOM_BYTE_SZ);
```

Parameters

Parameters	Description
rng	Pointer to context which saves state between calls.
b	Pointer to buffer to store the random numbers.
sz	Number of 8-bit random numbers to generate.

Function

```
int CRYPT_RNG_BlockGenerate( CRYPT_RNG_CTX* rng, unsigned char* b, unsigned int sz)
```

CRYPT_RNG_Get Function

Gets one random number.

File

[crypto.h](#)

C

```
int CRYPT_RNG_Get(CRYPT_RNG_CTX*, unsigned char*);
```

Returns

- BAD_FUNC_ARG - An invalid pointer was passed to the function.
- Less than 0 - An error occurred.
- 0 or greater - Success.

Description

This function gets one random number from the random number generator.

Preconditions

RNG context was initialized using the [CRYPT_RNG_Initialize](#) function.

Example

```
#define RANDOM_BYTE_SZ 32

int         ret;
CRYPT_RNG_CTX mcRng;
byte        out[RANDOM_BYTE_SZ];

ret = CRYPT_RNG_Initialize(&mcRng);

ret = CRYPT_RNG_Get(&mcRng, &out[0]);

ret = CRYPT_RNG_BlockGenerate(&mcRng, out, RANDOM_BYTE_SZ);
```

Parameters

Parameters	Description
rng	Pointer to context which saves state between calls.
b	Pointer to 8-bit location to store the result.

Function

```
int CRYPT_RNG_Get( CRYPT_RNG_CTX* rng, unsigned char* b)
```

e) AES Encryption/Decryption Functions

CRYPT_AES_CBC_Decrypt Function

Performs AES decryption using Cipher-Block-Chaining (CBC).

File

[crypto.h](#)

C

```
int CRYPT_AES_CBC_Decrypt(CRYPT_AES_CTX*, unsigned char*, const unsigned char*, unsigned int);
```

Returns

- BAD_FUNC_ARG - An invalid pointer was passed to the function.
- 0 - An invalid pointer was not passed to the function.

Description

This function decrypts a block of data using the AES algorithm in Cipher-Block-Chaining (CBC) mode.

Remarks

The output buffer must be equal in size to the input buffer.

Preconditions

Key and Initialization Vector (IV) must be set earlier with a call to [CRYPT_AES_KeySet](#) and [CRYPT_AES_IvSet](#).

Example

```
CRYPT_AES_CTX mcAes;
int         ret;
byte        out1[AES_TEST_SIZE];
byte        out2[AES_TEST_SIZE];

strncpy((char*)key, "1234567890abcdefghijklmnopqrstuv", 32);
strncpy((char*)iv, "1234567890abcdef", 16);

ret = CRYPT_AES_KeySet(&mcAes, key, 16, iv, CRYPT_AES_ENCRYPTION);
ret = CRYPT_AES_CBC_Decrypt(&mcAes, out2, out1, AES_TEST_SIZE);
```

Parameters

Parameters	Description
aes	Pointer to context which saves state between calls.
out	Pointer to buffer to store the results of the decryption pass.
in	Pointer to buffer holding the data to be decrypted.
inSz	Size of the input data, in bytes.

Function

```
int CRYPT_AES_CBC_Decrypt( CRYPT_AES_CTX* aes, unsigned char* out,
const unsigned char* in, unsigned int inSz)
```

CRYPT_AES_CBC_Encrypt Function

Performs AES encryption using Cipher-Block-Chaining (CBC).

File

[crypto.h](#)

C

```
int CRYPT_AES_CBC_Encrypt(CRYPT_AES_CTX*, unsigned char*, const unsigned char*, unsigned int);
```

Returns

- BAD_FUNC_ARG - An invalid pointer was passed to the function.
- 0 - An invalid pointer was not passed to the function.

Description

This function encrypts a block of data using the AES algorithm in Cipher-Block-Chaining (CBC) mode.

Remarks

The output buffer must be equal in size to the input buffer.

Preconditions

Key and Initialization Vector (IV) must be set earlier with a call to [CRYPT_AES_KeySet](#) and [CRYPT_AES_IvSet](#).

Example

```
CRYPT_AES_CTX mcAes;
int          ret;
byte        out1[AES_TEST_SIZE];

strncpy((char*)key, "1234567890abcdefghijklmnopqrstuv", 32);
strncpy((char*)iv, "1234567890abcdef", 16);

ret = CRYPT_AES_KeySet(&mcAes, key, 16, iv, CRYPT_AES_ENCRYPTION);
ret = CRYPT_AES_CBC_Encrypt(&mcAes, out1, ourData, AES_TEST_SIZE);
```

Parameters

Parameters	Description
aes	Pointer to context which saves state between calls.
out	Pointer to buffer to store the results of the encryption pass.
in	Pointer to buffer holding the data to be encrypted.
inSz	Size of the input data, in bytes.

Function

```
int CRYPT_AES_CBC_Encrypt( CRYPT_AES_CTX* aes, unsigned char* out,
const unsigned char* in, unsigned int inSz)
```

CRYPT_AES_CTR_Encrypt Function

Performs AES encryption using Counter (CTR).

File

[crypto.h](#)

C

```
int CRYPT_AES_CTR_Encrypt(CRYPT_AES_CTX*, unsigned char*, const unsigned char*, unsigned int);
```

Returns

- BAD_FUNC_ARG - An invalid pointer was passed to the function.
- 0 - An invalid pointer was not passed to the function.

Description

This function encrypts a block of data using the AES algorithm in Counter (CTR) mode.

Remarks

The output buffer must be equal in size to the input buffer.

Preconditions

Key and Initialization Vector (IV) must be set earlier with a call to [CRYPT_AES_KeySet](#) and [CRYPT_AES_IvSet](#).

Example

```
CRYPT_AES_CTX mcAes;
int          ret;
byte         out1[AES_TEST_SIZE];

strncpy((char*)key, "1234567890abcdefghijklmnopqrstuv", 32);
strncpy((char*)iv, "1234567890abcdef", 16);

ret = CRYPT_AES_KeySet(&mcAes, key, 16, iv, CRYPT_AES_ENCRYPTION);
ret = CRYPT_AES_CTR_Encrypt(&mcAes, out1, ourData, AES_TEST_SIZE);
```

Parameters

Parameters	Description
aes	Pointer to context which saves state between calls.
out	Pointer to buffer to store the results of the encryption pass.
in	Pointer to buffer holding the data to be encrypted.
inSz	Size of the input data, in bytes.

Function

```
int CRYPT_AES_CTR_Encrypt( CRYPT_AES_CTX* aes, unsigned char* out,
const unsigned char* in, unsigned int inSz)
```

CRYPT_AES_DIRECT_Decrypt Function

Directs decryption of one block of data.

File

[crypto.h](#)

C

```
int CRYPT_AES_DIRECT_Decrypt(CRYPT_AES_CTX*, unsigned char*, const unsigned char*);
```

Returns

- BAD_FUNC_ARG - An invalid pointer was passed to the function.
- 0 - An invalid pointer was not passed to the function.

Description

This function decrypts one block of data, equal to the AES block size.

Remarks

Input and output buffers must be equal in size (CRYPT_AES_BLOCK_SIZE).

Preconditions

Key and Initialization Vector (IV) must be set earlier with a call to [CRYPT_AES_KeySet](#) and [CRYPT_AES_IvSet](#).

Example

```
CRYPT_AES_CTX mcAes;
int          ret;
byte        out1[CRYPT_AES_BLOCK_SIZE];
byte        out2[CRYPT_AES_BLOCK_SIZE];

strncpy((char*)key, "1234567890abcdefghijklmnopqrstuv", 32);
strncpy((char*)iv, "1234567890abcdef", 16);

ret = CRYPT_AES_KeySet(&mcAes, key, 16, iv, CRYPT_AES_ENCRYPTION);
ret = CRYPT_AES_DIRECT_Decrypt(&mcAes, out2, out1);
```

Parameters

Parameters	Description
aes	Pointer to context which saves state between calls.
out	Pointer to buffer to store the results of the decryption.
in	Pointer to buffer where the data to decrypt is located.

Function

```
int CRYPT_AES_DIRECT_Decrypt( CRYPT_AES_CTX*, unsigned char*,
const unsigned char*)
```

CRYPT_AES_DIRECT_Encrypt Function

Directs encryption of one block of data.

File

[crypto.h](#)

C

```
int CRYPT_AES_DIRECT_Encrypt(CRYPT_AES_CTX*, unsigned char*, const unsigned char*);
```

Returns

- BAD_FUNC_ARG - An invalid pointer was passed to the function.
- 0 - An invalid pointer was not passed to the function.

Description

This function encrypts one block of data, equal to the AES block size.

Remarks

Input and output buffers must be equal in size (CRYPT_AES_BLOCK_SIZE).

Preconditions

Key and Initialization Vector (IV) must be set earlier with a call to [CRYPT_AES_KeySet](#) and [CRYPT_AES_IvSet](#).

Example

```
CRYPT_AES_CTX mcAes;
int          ret;
byte        out1[CRYPT_AES_BLOCK_SIZE];

strncpy((char*)key, "1234567890abcdefghijklmnopqrstuv", 32);
strncpy((char*)iv, "1234567890abcdef", 16);

ret = CRYPT_AES_KeySet(&mcAes, key, 16, iv, CRYPT_AES_ENCRYPTION);
ret = CRYPT_AES_DIRECT_Encrypt(&mcAes, out1, ourData);
```

Parameters

Parameters	Description
aes	Pointer to context which saves state between calls.

out	Pointer to buffer to store the results of the encryption.
in	Pointer to buffer where the data to encrypt is located.

Function

```
int CRYPT_AES_DIRECT_Encrypt( CRYPT_AES_CTX* aes, unsigned char* out,
const unsigned char* in)
```

CRYPT_AES_IvSet Function

Sets the initialization vector (IV) for AES processing.

File

[crypto.h](#)

C

```
int CRYPT_AES_IvSet( CRYPT_AES_CTX*, const unsigned char* );
```

Returns

- BAD_FUNC_ARG - An invalid pointer was passed to the function.
- 0 - An invalid pointer was not passed to the function.

Description

This function sets the IV that AES will use for later processing.

Remarks

Direction, as set previously in [CRYPT_AES_KeySet](#), is preserved.

Preconditions

The key must be set previously with [CRYPT_AES_KeySet](#).

Example

```
CRYPT_AES_CTX mcAes;
int          ret;

strncpy((char*)iv, "1234567890abcdef", 16);

ret = CRYPT_AES_IvSet(&mcAes, iv);
```

Parameters

Parameters	Description
aes	Pointer to context which saves state between calls.
iv	Pointer to buffer holding the initialization vector.

Function

```
int CRYPT_AES_IvSet( CRYPT_AES_CTX* aes, const unsigned char* iv)
```

CRYPT_AES_KeySet Function

Sets the key and initialization vector (IV) for AES processing.

File

[crypto.h](#)

C

```
int CRYPT_AES_KeySet( CRYPT_AES_CTX*, const unsigned char*, unsigned int, const unsigned char*, int );
```

Returns

- BAD_FUNC_ARG - An invalid pointer was passed to the function.
- 0 - An invalid pointer was not passed to the function.

Description

This function sets the key and IV, and the direction (encryption or decryption) that AES will later perform.

Preconditions

None.

Example

```
CRYPT_AES_CTX mcAes;
int          ret;

strncpy((char*)key, "1234567890abcdefghijklmnopqrstuv", 32);
strncpy((char*)iv, "1234567890abcdef", 16);

ret = CRYPT_AES_KeySet(&mcAes, key, 16, iv, CRYPT_AES_ENCRYPTION);
```

Parameters

Parameters	Description
aes	Pointer to context which saves state between calls.
key	Pointer to buffer holding the key itself.
keyLen	Length of key in bytes.
iv	Pointer to buffer holding the initialization vector.
dir	Which operation (CRYPT_AES_ENCRYPTION or CRYPT_AES_DECRYPTION).

Function

```
int CRYPT_AES_KeySet( CRYPT_AES_CTX* aes, const unsigned char* key,
unsigned int keylen, const unsigned char* iv, int dir)
```

f) ECC Encryption/Decryption Functions

CRYPT_ECC_DHE_KeyMake Function

Creates a new ECC key.

File

crypto.h

C

```
int CRYPT_ECC_DHE_KeyMake(CRYPT_ECC_CTX*, CRYPT_RNG_CTX*, int);
```

Returns

- BAD_FUNC_ARG - An invalid pointer was passed to the function.
- MEMORY_E - Could not create the memory buffer for the key.
- 0 - An invalid pointer was not passed to the function.

Description

This function creates a new ECC key.

Preconditions

The context must have been initialized with a call to [CRYPT_ECC_Initialize](#). The random number generator context must have been initialized with a call to [CRYPT_RNG_Initialize](#).

Example

```
CRYPT_ECC_CTX userA;
int          ret;
byte         sharedA[100];
unsigned int aSz = (unsigned int)sizeof(sharedA);
unsigned int usedA = 0;

ret = CRYPT_ECC_Initialize(&userA);
ret = CRYPT_ECC_DHE_KeyMake(&userA, &mcRng, 32);
```

Parameters

Parameters	Description
<code>ecc</code>	Pointer to context which saves state between calls.
<code>rng</code>	Pointer to the context for the random number generator.
<code>keySz</code>	The size of the key desired.

Function

```
int CRYPT_ECC_DHE_KeyMake( CRYPT_ECC_CTX*, CRYPT_RNG_CTX*, int)
```

CRYPT_ECC_DHE_SharedSecretMake Function

Creates an ECC shared secret between two keys.

File

[crypto.h](#)

C

```
int CRYPT_ECC_DHE_SharedSecretMake(CRYPT_ECC_CTX*, CRYPT_ECC_CTX*, unsigned char*, unsigned int, unsigned int*);
```

Returns

- `BAD_FUNC_ARG` - An invalid pointer was passed to the function.
- `MEMORY_E` - Could not create the memory buffer for the shared secret.
- `0` - An invalid pointer was not passed to the function.

Description

This function takes two ECC contexts (one public, one private) and creates a shared secret between the two. The secret conforms to EC-DH from ANSI X9.63.

Preconditions

Both contexts must have been initialized with a call to [CRYPT_ECC_Initialize](#). Both contexts have had their respective keys imported or created.

Example

```
CRYPT_ECC_CTX userA;
CRYPT_ECC_CTX userB;
int          ret;
byte        sharedA[100];
unsigned int aSz  = (unsigned int)sizeof(sharedA);
unsigned int usedA = 0;

ret = CRYPT_ECC_Initialize(&userA);
ret = CRYPT_ECC_Initialize(&userB);
...
// Make or import the appropriate keys
...
ret = CRYPT_ECC_DHE_SharedSecretMake(&userA, &userB, sharedA, aSz, &usedA);
```

Parameters

Parameters	Description
<code>priv</code>	Pointer to the private ECC context (with the private key).
<code>pub</code>	Pointer to the public ECC context (with the public key).
<code>out</code>	Destination of the shared secret.
<code>outSz</code>	The max size of the shared secret.
<code>usedSz</code>	Resulting size of the shared secret.

Function

```
int CRYPT_ECC_DHE_SharedSecretMake( CRYPT_ECC_CTX* priv, CRYPT_ECC_CTX* pub,
unsigned char* out, unsigned int outSz, unsigned int* usedSz)
```

CRYPT_ECC_DSA_HashSign Function

Signs a message digest.

File

crypto.h

C

```
int CRYPT_ECC_DSA_HashSign(CRYPT_ECC_CTX*, CRYPT_RNG_CTX*, unsigned char*, unsigned int, unsigned int*,
const unsigned char*, unsigned int);
```

Returns

- BAD_FUNC_ARG - An invalid pointer was passed to the function.
- 0 - An invalid pointer was not passed to the function.

Description

This function takes a message digest and signs it using a private ECC key.

Preconditions

The ECC context must have been initialized with a call to [CRYPT_ECC_Initialize](#). The RNG context must have been initialized with a call to [CRYPT_RNG_Initialize](#). The private key used for the signature must have been imported or created prior to calling this function.

Example

```
CRYPT_ECC_CTX userA;
int          ret;
byte        sig[100];
unsigned int sigSz = (unsigned int)sizeof(sig);
unsigned int usedA = 0;

ret = CRYPT_ECC_Initialize(&userA);
...
// Import or generate private key
...
ret = CRYPT_ECC_DSA_HashSign(&userA, &mcRng, sig, sigSz, &usedA, ourData,
CRYPT_SHA_DIGEST_SIZE);
```

Parameters

Parameters	Description
ecc	Pointer to ECC context which saves state between calls and holds keys.
rng	Pointer to Random Number Generator context.
sig	Destination for the signature.
sigSz	The max size of the signature, in bytes.
usedSz	The resulting size of the signature, in bytes.
in	Pointer to the message digest to sign.
inSz	The length of the digest, in bytes.

Function

```
int CRYPT_ECC_DSA_HashSign( CRYPT_ECC_CTX* ecc, CRYPT_RNG_CTX* rng, unsigned char* sig,
unsigned int sigSz, unsigned int* usedSz, const unsigned char* in, unsigned int inSz)
```

CRYPT_ECC_DSA_HashVerify Function

Verifies an ECC signature.

File

crypto.h

C

```
int CRYPT_ECC_DSA_HashVerify(CRYPT_ECC_CTX*, const unsigned char*, unsigned int, unsigned char*, unsigned
int, int*);
```

Returns

- BAD_FUNC_ARG - An invalid pointer was passed to the function.
- MEMORY_E - Memory could not be allocated for the operation.
- 0 - An invalid pointer was not passed to the function.

Description

This function verifies that an ECC signature is valid.

Preconditions

The ECC context must have been initialized with a call to [CRYPT_ECC_Initialize](#). The key used for the signature must have been imported or created prior to calling this function.

Example

```
CRYPT_ECC_CTX userA;
int          ret;
byte        sig[100];
unsigned int sigSz = (unsigned int)sizeof(sig);
unsigned int usedA = 0;
int verifyStatus = 0;

ret = CRYPT_ECC_Initialize(&userA);
...
// Import or generate private key
...
ret = CRYPT_ECC_DSA_HashVerify(&userA, sig, sigSz, ourData,
                              CRYPT_SHA_DIGEST_SIZE, &verifyStatus);
```

Parameters

Parameters	Description
ecc	Pointer to context which saves state between calls.
sig	The signature to verify.
sigSz	The length of the signature (octets).
hash	The hash (message digest) that was signed.
hashSz	The length of the hash (octets).
status	Result of signature (1 == valid, 0 == invalid).

Function

int CRYPT_ECC_DSA_HashVerify([CRYPT_ECC_CTX*](#) ecc, const unsigned char* sig, unsigned int sigSz, unsigned char* hash, unsigned int hashSz, int* status)

CRYPT_ECC_Free Function

Cleans up an Elliptic Curve Cryptography (ECC) Context.

File

[crypto.h](#)

C

```
int CRYPT_ECC_Free(CRYPT_ECC_CTX*);
```

Returns

- BAD_FUNC_ARG - An invalid pointer was passed to the function.
- 0 - An invalid pointer was not passed to the function.

Description

This function cleans up memory allocated for an ECC Context.

Preconditions

The context must have been initialized previously with a call to [CRYPT_ECC_Initialize](#).

Example

```
CRYPT_ECC_CTX userA;
int          ret;

ret = CRYPT_ECC_Initialize(&userA);
...
ret = CRYPT_ECC_Free(&userA);
```

Parameters

Parameters	Description
ecc	Pointer to context to clean up.

Function

```
int CRYPT_ECC_Free( CRYPT_ECC_CTX* ecc)
```

CRYPT_ECC_Initialize Function

Initializes the context for Elliptic Curve Cryptography (ECC).

File

[crypto.h](#)

C

```
int CRYPT_ECC_Initialize(CRYPT_ECC_CTX*);
```

Returns

- BAD_FUNC_ARG - An invalid pointer was passed to the function.
- -1 - Unable to allocate memory for the keys.
- 0 - An invalid pointer was not passed to the function.

Description

This function initializes the context used for Elliptic Curve Cryptography (ECC). The context is then passed to calls to perform key building, encryption, decryption, etc.

Preconditions

None.

Example

```
CRYPT_ECC_CTX userA;
int          ret;

ret = CRYPT_ECC_Initialize(&userA);
```

Parameters

Parameters	Description
ecc	Pointer to context to initialize.

Function

```
int CRYPT_ECC_Initialize( CRYPT_ECC_CTX* ecc)
```

CRYPT_ECC_KeySizeGet Function

Returns the key size in octets.

File

[crypto.h](#)

C

```
int CRYPT_ECC_KeySizeGet(CRYPT_ECC_CTX*);
```

Returns

- BAD_FUNC_ARG - An invalid pointer was passed to the function.
- int - The size of the key, in octets.

Description

This function returns the size of the ECC key, in octets.

Preconditions

The ECC context must have been initialized with a call to [CRYPT_ECC_Initialize](#). The key must have been imported or created prior to calling this function.

Example

```
CRYPT_ECC_CTX userA;
int          ret;
byte        sig[100];
unsigned int sigSz = (unsigned int)sizeof(sig);
unsigned int usedA = 0;

ret = CRYPT_ECC_Initialize(&userA);
...
// Import or generate private key
...
ret = CRYPT_ECC_KeySizeGet(&userA);
```

Parameters

Parameters	Description
ecc	Pointer to context which saves state between calls and contains the key.

Function

```
int CRYPT_ECC_KeySizeGet( CRYPT_ECC_CTX* ecc)
```

CRYPT_ECC_PrivateImport Function

Imports private key pair in X9.63 format.

File

[crypto.h](#)

C

```
int CRYPT_ECC_PrivateImport(CRYPT_ECC_CTX*, const unsigned char*, unsigned int, const unsigned char*, unsigned int);
```

Returns

- BAD_FUNC_ARG - An invalid pointer was passed to the function.
- 0 - An invalid pointer was not passed to the function.

Description

This function imports a public/private key pair in X9.63 format.

Preconditions

The context must have been initialized with a call to [CRYPT_ECC_Initialize](#).

Example

```
CRYPT_ECC_CTX ecc;

CRYPT_ECC_Initialize(&ecc);
...
CRYPT_ECC_PrivateImport(&ecc, priv_key, sizeof(priv_key), pub_key, sizeof(pub_key));
```

Parameters

Parameters	Description
ecc	Pointer to context which saves state between calls.

priv	Pointer to the private key.
privSz	Size of the private key, in bytes.
pub	Pointer to the public key.
pubSz	Size of the public key, in bytes.

Function

```
int CRYPT_ECC_PrivateImport( CRYPT_ECC_CTX* ecc, const unsigned char* priv,
    unsigned int privSz, const unsigned char* pub,
    unsigned int pubSz)
```

CRYPT_ECC_PublicExport Function

Exports public ECC key in ANSI X9.63 format.

File

[crypto.h](#)

C

```
int CRYPT_ECC_PublicExport(CRYPT_ECC_CTX*, unsigned char*, unsigned int, unsigned int*);
```

Returns

- BAD_FUNC_ARG - An invalid pointer was passed to the function.
- BUFFER_E - The output buffer was too small to store the key.
- 0 - An invalid pointer was not passed to the function.

Description

This function takes an ECC public key and exports it in ANSI X9.63 format.

Preconditions

The context must be initialized previously with a call to [CRYPT_ECC_Initialize](#). The key must also have been constructed with a call to [CRYPT_ECC_DHE_KeyMake](#). A random number generator must all have been initialized with a call to [CRYPT_RNG_Initialize](#).

Example

```
CRYPT_ECC_CTX userA;
int          ret;
byte        sharedA[100];
unsigned int aSz = (unsigned int)sizeof(sharedA);
unsigned int usedA = 0;

ret = CRYPT_ECC_Initialize(&userA);
ret = CRYPT_ECC_DHE_KeyMake(&userA, &mcRng, 32);
ret = CRYPT_ECC_PublicExport(&userA, sharedA, aSz, &usedA);
```

Parameters

Parameters	Description
ecc	Pointer to context which saves state between calls.
out	Buffer in which to store the public key.
outSz	The available size of the buffer, in bytes.
usedSz	Return value indicating how many bytes were used.

Function

```
int CRYPT_ECC_PublicExport( CRYPT_ECC_CTX* ecc, unsigned char* out,
    unsigned int outSz, unsigned int* usedSz)
```

CRYPT_ECC_PublicImport Function

Imports public key in ANSI X9.63 format.

File

[crypto.h](#)

C

```
int CRYPT_ECC_PublicImport(CRYPT_ECC_CTX*, const unsigned char*, unsigned int);
```

Returns

- BAD_FUNC_ARG - An invalid pointer was passed to the function.
- MEMORY_E - Memory could not be allocated for the key.
- ASN_PARSE_E - There was a parse error while going through the key.
- 0 - An invalid pointer was not passed to the function.

Description

This function imports a public key in ANSI X9.63 format into the ECC context.

Preconditions

The ECC context must have previously been initialized with a call to [CRYPT_ECC_Initialize](#).

Example

```
CRYPT_ECC_CTX userB;
int          ret;
byte        sharedA[100];
unsigned int aSz = (unsigned int)sizeof(sharedA);
unsigned int usedA;

ret = CRYPT_ECC_Initialize(&userB);
...
ret = CRYPT_ECC_PublicImport(&userB, sharedA, usedA);
```

Parameters

Parameters	Description
ecc	Pointer to context which saves state between calls.
in	Input buffer the holds the public key.
inSz	Size of the input buffer, in bytes.

Function

```
int CRYPT_ECC_PublicImport( CRYPT_ECC_CTX* ecc, const unsigned char* in,
unsigned int inSz)
```

CRYPT_ECC_SignatureSizeGet Function

Returns the signature size in octets.

File

[crypto.h](#)

C

```
int CRYPT_ECC_SignatureSizeGet(CRYPT_ECC_CTX*);
```

Returns

- BAD_FUNC_ARG - An invalid pointer was passed to the function.
- int - The size of the signature.

Description

This function returns the size of the signature in a given context, in octets.

Preconditions

The ECC context must have been initialized with a call to [CRYPT_ECC_Initialize](#). The keys must have been imported or created prior to calling this function.

Example

```
CRYPT_ECC_CTX userA;
int          ret;
byte        sig[100];
unsigned int sigSz = (unsigned int)sizeof(sig);
```

```

unsigned int usedA = 0;

ret = CRYPT_ECC_Initialize(&userA);
...
// Import or generate private key
...
ret = CRYPT_ECC_SignatureSizeGet(&userA);

```

Parameters

Parameters	Description
ecc	Pointer to context which saves state between calls, and contains the signature.

Function

```
int CRYPT_ECC_SignatureSizeGet( CRYPT\_ECC\_CTX\* ecc)
```

g) RSA Encryption/Decryption Functions

CRYPT_RSA_EncryptSizeGet Function

Gets the size of the RSA Key.

File

[crypto.h](#)

C

```
int CRYPT_RSA_EncryptSizeGet(CRYPT_RSA_CTX*);
```

Returns

- BAD_FUNC_ARG - An invalid pointer was passed to the function.
- int - Size of the key.

Description

This function retrieves the size of the RSA Key in use for the context.

Preconditions

The context must be initialized with a call to [CRYPT_RSA_Initialize](#) and the keys decoded either with [CRYPT_RSA_PrivateKeyDecode](#) or [CRYPT_RSA_PublicKeyDecode](#).

Example

```

CRYPT_RSA_CTX mcRsa;
int ret;
unsigned int keySz = (unsigned int)sizeof(client_key_der_1024);
byte out1[256];

ret = CRYPT_RSA_Initialize(&mcRsa);

ret = CRYPT_RSA_PrivateKeyDecode(&mcRsa, client_key_der_1024, keySz);

ret = CRYPT_RSA_EncryptSizeGet(&mcRsa);

```

Parameters

Parameters	Description
rsa	Pointer to context which saves state between calls.

Function

```
int CRYPT_RSA_EncryptSizeGet( CRYPT\_RSA\_CTX\* rsa)
```

CRYPT_RSA_Free Function

Releases the memory used for the key and clean up the context.

File[crypto.h](#)**C**

```
int CRYPT_RSA_Free(CRYPT_RSA_CTX*);
```

Returns

- BAD_FUNC_ARG - An invalid pointer was passed to the function.
- 0 - An invalid pointer was not passed to the function.

Description

This function releases the memory used during RSA processing for storing the public/private key.

Preconditions

The context must have been set up previously with a call to [CRYPT_RSA_Initialize](#).

Example

```
CRYPT_RSA_CTX mcRsa;
int          ret;

ret = CRYPT_RSA_Initialize(&mcRsa);
ret = CRYPT_RSA_Free(&mcRsa);
```

Parameters

Parameters	Description
rsa	Pointer to context which saves state between calls.

Function

```
int CRYPT_RSA_Free( CRYPT_RSA_CTX* rsa)
```

CRYPT_RSA_Initialize Function

Initializes the internal structures necessary for RSA processing.

File[crypto.h](#)**C**

```
int CRYPT_RSA_Initialize(CRYPT_RSA_CTX*);
```

Returns

- BAD_FUNC_ARG - An invalid pointer was passed to the function.
- -1 - Unable to allocate the memory necessary for the key.
- 0 - An invalid pointer was not passed to the function.

Description

This function initializes the context used during public-key RSA encryption and decryption.

Preconditions

None.

Example

```
CRYPT_RSA_CTX mcRsa;
int          ret;

ret = CRYPT_RSA_Initialize(&mcRsa);
```

Parameters

Parameters	Description
rsa	Pointer to RSA context which saves state between calls.

Function

```
int CRYPT_RSA_Initialize( CRYPT_RSA_CTX* rsa)
```

CRYPT_RSA_PrivateDecrypt Function

Decrypts data using a private key.

File

[crypto.h](#)

C

```
int CRYPT_RSA_PrivateDecrypt(CRYPT_RSA_CTX*, unsigned char*, unsigned int, const unsigned char*, unsigned int);
```

Returns

- BAD_FUNC_ARG - An invalid pointer was passed to the function.
- int - Size of the actual output.

Description

This function decrypts a data block using a private key.

Preconditions

The context must be initialized using `CRYPT_RSA_Initialize` and the Private Key Decoded using `CRYPT_RSA_PrivateKeyDecode` prior to calling this function.

Example

```
CRYPT_RSA_CTX mcRsa;
int          ret;
unsigned int keySz = (unsigned int)sizeof(client_key_der_1024);
byte        out1[256];

ret = CRYPT_RSA_Initialize(&mcRsa);

ret = CRYPT_RSA_PrivateKeyDecode(&mcRsa, client_key_der_1024, keySz);

ret = CRYPT_RSA_PrivateDecrypt(&mcRsa, out2, sizeof(out2), out1,
                              RSA_TEST_SIZE);
```

Parameters

Parameters	Description
rsa	Pointer to context which saves state between calls.
out	Pointer to output buffer to store results.
outSz	Size of output buffer.
in	Pointer to source buffer to be decrypted.
inSz	Size of input buffer.

Function

```
int CRYPT_RSA_PrivateDecrypt( CRYPT_RSA_CTX* rsa, unsigned char* out,
unsigned int outSz, const unsigned char* in, unsigned int inSz)
```

CRYPT_RSA_PrivateKeyDecode Function

Constructs the Private Key from a DER certificate.

File

[crypto.h](#)

C

```
int CRYPT_RSA_PrivateKeyDecode(CRYPT_RSA_CTX*, const unsigned char*, unsigned int);
```

Returns

- BAD_FUNC_ARG - An invalid pointer was passed to the function.
- 0 - An invalid pointer was not passed to the function.

Description

This function builds a private key from a DER-formatted certificate. DER stands for Distinguished Encoding Rules.

Preconditions

The context must have been initialized with a call to [CRYPT_RSA_Initialize](#).

Example

```
CRYPT_RSA_CTX mcRsa;
int         ret;
unsigned int keySz = (unsigned int)sizeof(client_key_der_1024);

ret = CRYPT_RSA_Initialize(&mcRsa);

ret = CRYPT_RSA_PrivateKeyDecode(&mcRsa, client_key_der_1024, keySz);
```

Parameters

Parameters	Description
rsa	Pointer to context which saves state between calls.
in	Pointer to buffer containing the certificate to process to extract the private key.
inSz	Size of the input data in bytes.

Function

```
int CRYPT_RSA_PrivateKeyDecode( CRYPT_RSA_CTX*, const unsigned char*,
unsigned int)
```

CRYPT_RSA_PublicEncrypt Function

Encrypts data using a public key.

File

[crypto.h](#)

C

```
int CRYPT_RSA_PublicEncrypt(CRYPT_RSA_CTX*, unsigned char*, unsigned int, const unsigned char*, unsigned
int, CRYPT_RNG_CTX*);
```

Returns

- BAD_FUNC_ARG - An invalid pointer was passed to the function.
- int - Size of the actual output.

Description

This function encrypts a data block using a public key.

Preconditions

The context must be initialized using [CRYPT_RSA_Initialize](#) and the Public Key Decoded using [CRYPT_RSA_PublicKeyDecode](#) prior to calling this function. The random number generator must be initialized with a call to [CRYPT_RNG_Initialize](#).

Example

```
CRYPT_RSA_CTX mcRsa;
CRYPT_RNG_CTX mcRng;
int         ret;
unsigned int keySz = (unsigned int)sizeof(client_key_der_1024);
byte        out1[256];

ret = CRYPT_RSA_Initialize(&mcRsa);
ret = CRYPT_RNG_Initialize(&mcRng);

ret = CRYPT_RSA_PublicKeyDecode(&mcRsa, client_key_der_1024, keySz);
```

```
ret = CRYPT_RSA_PublicEncrypt(&mcRsa, out1, sizeof(out1), ourData,
                             RSA_TEST_SIZE, &mcRng);
```

Parameters

Parameters	Description
rsa	Pointer to context which saves state between calls.
out	Pointer to output buffer to store results.
outSz	Size of output buffer.
in	Pointer to source buffer to be encrypted.
inSz	Size of input buffer.
rng	Pointer to Random Number Generator (RNG) context.

Function

```
int CRYPT_RSA_PublicEncrypt( CRYPT_RSA_CTX* rsa, unsigned char* out,
                             unsigned int outSz, const unsigned char* in, unsigned int inSz,
                             CRYPT_RNG_CTX* rng)
```

CRYPT_RSA_PublicKeyDecode Function

Constructs the Public Key from a DER certificate.

File

[crypto.h](#)

C

```
int CRYPT_RSA_PublicKeyDecode(CRYPT_RSA_CTX*, const unsigned char*, unsigned int);
```

Returns

- BAD_FUNC_ARG - An invalid pointer was passed to the function.
- 0 - An invalid pointer was not passed to the function.

Description

This function builds a public key from a DER-formated certificate. DER stands for Distinguished Encoding Rules.

Preconditions

The context must have been initialized with a call to [CRYPT_RSA_Initialize](#).

Example

```
CRYPT_RSA_CTX mcRsa;
int ret;
unsigned int keySz = (unsigned int)sizeof(client_key_der_1024);

ret = CRYPT_RSA_Initialize(&mcRsa);

ret = CRYPT_RSA_PublicKeyDecode(&mcRsa, client_key_der_1024, keySz);
```

Parameters

Parameters	Description
rsa	Pointer to context which saves state between calls.
in	Pointer to buffer containing the certificate to process to extract the public key.
inSz	Size of the input data in bytes.

Function

```
int CRYPT_RSA_PublicKeyDecode( CRYPT_RSA_CTX* rsa, const unsigned char* in,
                             unsigned int inSz)
```

h) Triple DES (3DES) Encryption/Decryption Functions

CRYPT_TDES_CBC_Decrypt Function

Decrypts a data block using Triple DES.

File

[crypto.h](#)

C

```
int CRYPT_TDES_CBC_Decrypt(CRYPT_TDES_CTX*, unsigned char*, const unsigned char*, unsigned int);
```

Returns

- BAD_FUNC_ARG - An invalid pointer was passed to the function.
- 0 - An invalid pointer was not passed to the function.

Description

This function decrypts a block of data using a Triple DES algorithm.

Remarks

Input data must have a length a multiple of 8 bytes. Output data will be zero-padded at the end if the original data was not a multiple of 8 bytes long.

Preconditions

The context tdes must be set earlier using [CRYPT_TDES_KeySet](#). The input block must be a multiple of 8 bytes long.

Example

```
CRYPT_TDES_CTX mcDes3;
int          ret;
byte        out1[TDES_SIZE];
byte        out2[TDES_SIZE];

strncpy((char*)key, "1234567890abcdefghijklmnop", 24);
strncpy((char*)iv, "12345678", 8);

ret = CRYPT_TDES_KeySet(&mcDes3, key, iv, CRYPT_TDES_ENCRYPTION);

ret = CRYPT_TDES_CBC_Encrypt(&mcDes3, out1, ourData, TDES_SIZE);

ret = CRYPT_TDES_KeySet(&mcDes3, key, iv, CRYPT_TDES_DECRYPTION);

ret = CRYPT_TDES_CBC_Decrypt(&mcDes3, out2, out1, TDES_TEST_SIZE);
```

Parameters

Parameters	Description
tdes	Pointer to context which saves state between calls.
out	Pointer to output buffer to store the results.
in	Pointer to input buffer for the source of the data.
inSz	Size of the input data buffer.

Function

```
int CRYPT_TDES_CBC_Decrypt( CRYPT_TDES_CTX* tdes, unsigned char* out, const unsigned char* in, unsigned int inSz)
```

CRYPT_TDES_CBC_Encrypt Function

Encrypts a data block using Triple DES.

File

[crypto.h](#)

C

```
int CRYPT_TDES_CBC_Encrypt(CRYPT_TDES_CTX*, unsigned char*, const unsigned char*, unsigned int);
```

Returns

- BAD_FUNC_ARG - An invalid pointer was passed to the function.
- 0 - An invalid pointer was not passed to the function.

Description

This function encrypts a block of data using a Triple DES algorithm.

Remarks

The input data must be padded at the end with zeros to make the length a multiple of 8.

Preconditions

The context tdes must be set earlier using [CRYPT_TDES_KeySet](#). The input block must be a multiple of 8 bytes long.

Example

```
CRYPT_TDES_CTX mcDes3;
int           ret;
byte         out1[TDES_SIZE];
byte         out2[TDES_SIZE];

strncpy((char*)key, "1234567890abcdefghijklmn", 24);
strncpy((char*)iv, "12345678", 8);

ret = CRYPT_TDES_KeySet(&mcDes3, key, iv, CRYPT_TDES_ENCRYPTION);

ret = CRYPT_TDES_CBC_Encrypt(&mcDes3, out1, ourData, TDES_SIZE);

ret = CRYPT_TDES_KeySet(&mcDes3, key, iv, CRYPT_TDES_DECRYPTION);

ret = CRYPT_TDES_CBC_Decrypt(&mcDes3, out2, out1, TDES_TEST_SIZE);
```

Parameters

Parameters	Description
tdes	Pointer to context which saves state between calls.
out	Pointer to output buffer to store the results.
in	Pointer to input buffer for the source of the data.
inSz	Size of the input data buffer.

Function

int CRYPT_TDES_CBC_Encrypt([CRYPT_TDES_CTX*](#) tdes, unsigned char* out, const unsigned char* in, unsigned int inSz)

CRYPT_TDES_IvSet Function

Sets the Initialization Vector (IV) for a Triple DES operation.

File

[crypto.h](#)

C

```
int CRYPT_TDES_IvSet(CRYPT_TDES_CTX*, const unsigned char*);
```

Returns

- BAD_FUNC_ARG - An invalid pointer was passed to the function.
- 0 - An invalid pointer was not passed to the function.

Description

This function changes the IV of a TDES context, but leaves the Key alone.

Remarks

The IV must be 8 bytes long.

Preconditions

None.

Example

```

CRYPT_TDES_CTX mcDes3;
int          ret;
byte        out1[TDES_SIZE];
byte        out2[TDES_SIZE];

strncpy((char*)key, "1234567890abcdefghijklmn", 24);
strncpy((char*)iv, "12345678", 8);

ret = CRYPT_TDES_KeySet(&mcDes3, key, iv, CRYPT_TDES_ENCRYPTION);

ret = CRYPT_TDES_IvSet(&mcDes3, iv);

ret = CRYPT_TDES_CBC_Encrypt(&mcDes3, out1, ourData, TDES_SIZE);

ret = CRYPT_TDES_KeySet(&mcDes3, key, iv, CRYPT_TDES_DECRYPTION);

ret = CRYPT_TDES_CBC_Decrypt(&mcDes3, out2, out1, TDES_TEST_SIZE);

```

Parameters

Parameters	Description
tDES	Pointer to context which saves state between calls.
iv	Pointer to buffer holding the initialization vector. Must be 8 bytes in size.

Function

```
int CRYPT_TDES_IvSet( CRYPT_TDES_CTX* tDES, const unsigned char* iv)
```

CRYPT_TDES_KeySet Function

Initialization of Triple DES context.

File

[crypto.h](#)

C

```
int CRYPT_TDES_KeySet(CRYPT_TDES_CTX*, const unsigned char*, const unsigned char*, int);
```

Returns

- BAD_FUNC_ARG - An invalid pointer was passed to the function.
- 0 - An invalid pointer was not passed to the function.

Description

This function sets the key and initialization vector (IV) for a set of Triple-DES operations.

Remarks

The input data must be a multiple of 8 bytes, and must be padded at the end with zeros to meet the length.

Preconditions

None.

Example

```

CRYPT_TDES_CTX mcDes3;
int          ret;
byte        out1[TDES_SIZE];
byte        out2[TDES_SIZE];

strncpy((char*)key, "1234567890abcdefghijklmn", 24);
strncpy((char*)iv, "12345678", 8);

ret = CRYPT_TDES_KeySet(&mcDes3, key, iv, CRYPT_TDES_ENCRYPTION);

ret = CRYPT_TDES_CBC_Encrypt(&mcDes3, out1, ourData, TDES_SIZE);

ret = CRYPT_TDES_KeySet(&mcDes3, key, iv, CRYPT_TDES_DECRYPTION);

```

```
ret = CRYPT_TDES_CBC_Decrypt(&mcDes3, out2, out1, TDES_TEST_SIZE);
```

Parameters

Parameters	Description
tdes	Pointer to context which saves state between calls.
key	Pointer to buffer holding the key. Must be 24 bytes in size.
iv	Pointer to buffer holding the initialization vector. Must be 8 bytes in size.
dir	Indicates whether encryption or decryption will be done. Can be set to: <ul style="list-style-type: none"> CRYPT_TDES_ENCRYPTION - For Encryption operations CRYPT_TDES_DECRYPTION - Fro Decryption operations

Function

```
int CRYPT_TDES_KeySet( CRYPT_TDES_CTX* tdes, const unsigned char* key, const unsigned char* iv, int dir)
```

i) HMAC Hash Functions

CRYPT_HMAC_DataAdd Function

Adds data to the HMAC calculation.

File

crypto.h

C

```
int CRYPT_HMAC_DataAdd(CRYPT_HMAC_CTX*, const unsigned char*, unsigned int);
```

Returns

- BAD_FUNC_ARG - An invalid pointer was passed to the function.
- 0 - An invalid pointer was not passed to the function.

Description

This function adds data to the HMAC so that multiple blocks of data can be processed.

Remarks

None.

Preconditions

The `CRYPT_HMAC_CTX` context must be initialized using the `CRYPT_HMAC_SetKey` function prior to any call to this function.

Example

```
CRYPT_HMAC_CTX mcHmac;
byte          mcDigest[CRYPT_SHA512_DIGEST_SIZE];

CRYPT_HMAC_SetKey(&mcHmac, CRYPT_HMAC_SHA, key, 4);

CRYPT_HMAC_DataAdd(&mcHmac, ourData, OUR_DATA_SIZE);

CRYPT_HMAC_Finalize(&mcHmac, mcDigest);
```

Parameters

Parameters	Description
hmac	Pointer to context that saves state between calls.
sz	Size of the input data in bytes.

Function

```
int CRYPT_HMAC_DataAdd( CRYPT_HMAC_CTX*, const unsigned char*, unsigned int)
```

CRYPT_HMAC_Finalize Function

Completes the HMAC calculation and get the results.

File

[crypto.h](#)

C

```
int CRYPT_HMAC_Finalize(CRYPT_HMAC_CTX*, unsigned char*);
```

Returns

- BAD_FUNC_ARG - An invalid pointer was passed to the function.
- 0 - An invalid pointer was not passed to the function.

Description

This function completes the HMAC calculations. The results are placed in the location pointed to by digest.

Remarks

The area pointed to by digest must be large enough to hold the results.

Preconditions

The [CRYPT_HMAC_CTX](#) context must be initialized using the [CRYPT_HMAC_SetKey](#) function prior to any call to this function.

Example

```
CRYPT_HMAC_CTX mcHmac;
byte          mcDigest[CRYPT_SHA512_DIGEST_SIZE];

CRYPT_HMAC_SetKey(&mcHmac, CRYPT_HMAC_SHA, key, 4);

CRYPT_HMAC_DataAdd(&mcHmac, ourData, OUR_DATA_SIZE);

CRYPT_HMAC_Finalize(&mcHmac, mcDigest);
```

Parameters

Parameters	Description
hmac	Pointer to context which saves state between calls.
digest	Pointer to place to put the final HMAC digest results.

Function

```
int CRYPT_HMAC_Finalize( CRYPT_HMAC_CTX* hmac, unsigned char* digest)
```

CRYPT_HMAC_SetKey Function

Initializes the HMAC context and set the key for the hash.

File

[crypto.h](#)

C

```
int CRYPT_HMAC_SetKey(CRYPT_HMAC_CTX*, int, const unsigned char*, unsigned int);
```

Returns

- BAD_FUNC_ARG - An invalid pointer was passed to the function.
- 0 - An invalid pointer was not passed to the function.

Description

This function initializes the HMAC context and set the key for the hash.

Remarks

None.

Preconditions

None.

Example

```
CRYPT_HMAC_CTX mcHmac;
byte          mcDigest[CRYPT_SHA512_DIGEST_SIZE];

CRYPT_HMAC_SetKey(&mcHmac, CRYPT_HMAC_SHA, key, 4);

CRYPT_HMAC_DataAdd(&mcHmac, ourData, OUR_DATA_SIZE);

CRYPT_HMAC_Finalize(&mcHmac, mcDigest);
```

Parameters

Parameters	Description
hmac	Pointer to context which saves state between calls.
type	Type of SHA operation to use with HMAC. Must be one of the
following	<ul style="list-style-type: none"> CRYPT_HMAC_SHA CRYPT_HMAC_SHA256 CRYPT_HMAC_SHA384 CRYPT_HMAC_SHA512
key	Secret key used for the hash.
sz	Size of the input data in bytes.

Function

int CRYPT_HMAC_SetKey(CRYPT_HMAC_CTX* hmac, int type, const unsigned char* key, unsigned int sz)

j) SHA Hash functions

CRYPT_SHA_DataAdd Function

Updates the hash with the data provided.

File

crypto.h

C

```
int CRYPT_SHA_DataAdd(CRYPT_SHA_CTX*, const unsigned char*, unsigned int);
```

Returns

- BAD_FUNC_ARG - An invalid pointer was passed to the function, either in sha or input.
- 0 - An invalid pointer was not passed to the function.

Description

This function updates the hash with the data provided.

Remarks

In order to preserve the validity of the SHA hash, nothing must modify the context holding variable between calls to CRYPT_SHA_DataAdd.

Preconditions

The SHA context must be initialized prior to the first call of this function. The context must not be modified by code outside of this function.

Example

```
CRYPT_SHA_CTX sha;
uint8_t buffer[1024];
uint8_t shaSum[SHA_DIGEST_SIZE];

CRYPT_SHA_Initialize(&sha);
CRYPT_SHA_DataAdd(&sha, buffer, sizeof(buffer));
```

```
CRYPT_SHA_Finalize(&sha, shaSum);
```

Parameters

Parameters	Description
sha	Pointer to CRYPT_SHA_CTX structure which holds the hash values.
sz	Size of the data (in bytes) of the data to use to update the hash.

Function

```
int CRYPT_SHA_DataAdd( CRYPT_SHA_CTX* sha, const unsigned char* input, unsigned int sz)
```

CRYPT_SHA_Finalize Function

Finalizes the hash and puts the result into digest.

File

[crypto.h](#)

C

```
int CRYPT_SHA_Finalize(CRYPT_SHA_CTX*, unsigned char*);
```

Returns

- BAD_FUNC_ARG - An invalid pointer was passed to the function, either in sha or digest.
- 0 - An invalid pointer was not passed to the function.

Description

This function finalizes the hash and puts the result into digest.

Remarks

In order to preserve the validity of the SHA hash, nothing must modify the context holding variable between calls to [CRYPT_SHA_DataAdd](#) and [CRYPT_SHA_Finalize](#).

Preconditions

The SHA context must be initialized prior to calling this function. The context must not be modified by code outside of this function.

Example

```
CRYPT_SHA_CTX sha;
uint8_t buffer[1024];
uint8_t shaSum[SHA_DIGEST_SIZE];

CRYPT_SHA_Initialize(&sha);
CRYPT_SHA_DataAdd(&sha, buffer, sizeof(buffer));
CRYPT_SHA_Finalize(&sha, shaSum);
```

Parameters

Parameters	Description
sha	Pointer to CRYPT_SHA_CTX structure which holds the hash values.
digest	Pointer to byte array to store hash result.

Function

```
int CRYPT_SHA_Finalize( CRYPT_SHA_CTX* sha, unsigned char* digest)
```

CRYPT_SHA_Initialize Function

Initializes the internal structures necessary for SHA hash calculations.

File

[crypto.h](#)

C

```
int CRYPT_SHA_Initialize(CRYPT_SHA_CTX*);
```

Returns

- BAD_FUNC_ARG - An invalid pointer was passed to the function.
- 0 - An invalid pointer was not passed to the function.

Description

This function initializes the internal structures necessary for SHA hash calculations.

Remarks

All SHA hashes have to start at a particular value before adding new data to it. This function sets the necessary values for the structure.

Preconditions

None.

Example

```
CRYPT_SHA_CTX sha;
uint8_t shaSum[SHA_DIGEST_SIZE];

CRYPT_SHA_Initialize(&sha);
CRYPT_SHA_DataAdd(&sha, buffer, sizeof(buffer));
CRYPT_SHA_Finalize(&sha, shaSum);
```

Parameters

Parameters	Description
sha	Pointer to CRYPT_SHA_CTX structure which holds the hash values.

Function

```
int CRYPT_SHA_Initialize( CRYPT_SHA_CTX* sha)
```

CRYPT_SHA_DataSizeSet Function

For PIC32MZ hardware encryption, sets the size of the input data.

File

[crypto.h](#)

C

```
int CRYPT_SHA_DataSizeSet( CRYPT_SHA_CTX*, unsigned int);
```

Returns

- BAD_FUNC_ARG - An invalid pointer was passed to the function.
- 0 - An invalid pointer was not passed to the function.

Description

The PIC32MZ hardware encryption module needs to know the size of the data before it starts processing. This function sets that value.

Remarks

All SHA hashes have to start at a particular value before adding new data to it. This function sets the necessary values for the structure.

Preconditions

None.

Example

```
CRYPT_SHA_CTX sha;
uint8_t buffer[1024];
uint8_t shasum[SHA_DIGEST_SIZE];

CRYPT_SHA_Initialize(&sha);
CRYPT_SHA_DataSizeSet(&sha, sizeof(buffer));
CRYPT_SHA_DataAdd(&sha, buffer, sizeof(buffer));
CRYPT_SHA_Finalize(&sha, shasum);
```

Parameters

Parameters	Description
sha	Pointer to <code>CRYPT_SHA_CTX</code> structure which holds the hash values.
msgSize	Size of the data (in bytes) that will be processed.

Function

```
int CRYPT_SHA_DataSizeSet( CRYPT_SHA_CTX* sha, unsigned int msgSize)
```

k) SHA256 Hash Functions

CRYPT_SHA256_DataAdd Function

Updates the hash with the data provided.

File

[crypto.h](#)

C

```
int CRYPT_SHA256_DataAdd(CRYPT_SHA256_CTX*, const unsigned char*, unsigned int);
```

Returns

- BAD_FUNC_ARG - An invalid pointer was passed to the function, either in sha256 or input.
- 0 - An invalid pointer was not passed to the function.

Description

This function updates the hash with the data provided.

Remarks

In order to preserve the validity of the SHA256 hash, nothing must modify the context holding variable between calls to `CRYPT_SHA256_DataAdd`.

Preconditions

The SHA256 context must be initialized prior to the first call of this function. The context must not be modified by code outside of this function.

Example

```
CRYPT_SHA256_CTX sha256;
uint8_t buffer[1024];
uint8_t shaSum[SHA256_DIGEST_SIZE];

CRYPT_SHA256_Initialize(&sha256);
CRYPT_SHA256_DataAdd(&sha256, buffer, sizeof(buffer));
CRYPT_SHA256_Finalize(&sha256, shaSum);
```

Parameters

Parameters	Description
sha256	Pointer to <code>CRYPT_SHA256_CTX</code> structure which holds the hash values.
sz	Size of the data (in bytes) of the data to use to update the hash.

Function

```
int CRYPT_SHA256_DataAdd( CRYPT_SHA256_CTX* sha256, const unsigned char* input, unsigned int sz)
```

CRYPT_SHA256_Finalize Function

Finalizes the hash and puts the result into digest.

File

[crypto.h](#)

C

```
int CRYPT_SHA256_Finalize(CRYPT_SHA256_CTX*, unsigned char*);
```

Returns

- BAD_FUNC_ARG - An invalid pointer was passed to the function, either in sha or digest.
- 0 - An invalid pointer was not passed to the function.

Description

This function finalizes the hash and puts the result into digest.

Remarks

In order to preserve the validity of the SHA256 hash, nothing must modify the context holding variable between calls to [CRYPT_SHA256_DataAdd](#) and [CRYPT_SHA256_Finalize](#).

Preconditions

The SHA256 context must be initialized prior to calling this function. The context must not be modified by code outside of this function.

Example

```
CRYPT_SHA256_CTX sha256;
uint8_t buffer[1024];
uint8_t shaSum[SHA256_DIGEST_SIZE];

CRYPT_SHA256_Initialize(&sha256);
CRYPT_SHA256_DataAdd(&sha256, buffer, sizeof(buffer));
CRYPT_SHA256_Finalize(&sha256, shaSum);
```

Parameters

Parameters	Description
sha256	Pointer to CRYPT_SHA256_CTX structure which holds the hash values.
digest	Pointer to byte array to store hash result.

Function

```
int CRYPT_SHA256_Finalize( CRYPT_SHA256_CTX* sha256, unsigned char* digest)
```

CRYPT_SHA256_Initialize Function

Initializes the internal structures necessary for SHA256 hash calculations.

File

[crypto.h](#)

C

```
int CRYPT_SHA256_Initialize(CRYPT_SHA256_CTX*);
```

Returns

- BAD_FUNC_ARG - An invalid pointer was passed to the function.
- 0 - An invalid pointer was not passed to the function.

Description

This function initializes the internal structures necessary for SHA256 hash calculations.

Remarks

All SHA hashes have to start at a particular value before adding new data to it. This function sets the necessary values for the structure.

Preconditions

None.

Example

```
CRYPT_SHA256_CTX sha;
uint8_t shaSum[SHA256_DIGEST_SIZE];

CRYPT_SHA256_Initialize(&sha);
CRYPT_SHA256_DataAdd(&sha, buffer, sizeof(buffer));
CRYPT_SHA256_Finalize(&sha, shaSum);
```

Parameters

Parameters	Description
sha256	Pointer to context which saves state between calls.

Function

```
int CRYPT_SHA256_Initialize( CRYPT_SHA256_CTX* sha256)
```

CRYPT_SHA256_DataSizeSet Function

For PIC32MZ hardware encryption, sets the size of the input data.

File

[crypto.h](#)

C

```
int CRYPT_SHA256_DataSizeSet(CRYPT_SHA256_CTX*, unsigned int);
```

Returns

- BAD_FUNC_ARG - An invalid pointer was passed to the function.
- 0 - An invalid pointer was not passed to the function.

Description

The PIC32MZ hardware encryption module needs to know the size of the data before it starts processing. This function sets that value.

Remarks

All SHA256 hashes have to start at a particular value before adding new data to it. This function sets the necessary values for the structure.

Preconditions

None.

Example

```
CRYPT_SHA256_CTX sha256;
uint8_t buffer[1024];
uint8_t sha256sum[SHA256_DIGEST_SIZE];

CRYPT_SHA256_Initialize(&sha256);
CRYPT_SHA256DataSizeSet(&sha256, sizeof(buffer));
CRYPT_SHA256_DataAdd(&sha256, buffer, sizeof(buffer));
CRYPT_SHA256_Finalize(&sha256, sha256sum);
```

Parameters

Parameters	Description
sha256	Pointer to CRYPT_SHA256_CTX structure which holds the hash values.
msgSize	Size of the data (in bytes) that will be processed.

Function

```
int CRYPT_SHA256_DataSizeSet( CRYPT_SHA256_CTX* sha256, unsigned int msgSize)
```

I) SHA384 Hash Functions

CRYPT_SHA384_DataAdd Function

Updates the hash with the data provided.

File

[crypto.h](#)

C

```
int CRYPT_SHA384_DataAdd(CRYPT_SHA384_CTX*, const unsigned char*, unsigned int);
```

Returns

- BAD_FUNC_ARG - An invalid pointer was passed to the function, either in sha384 or input.
- 0 - An invalid pointer was not passed to the function.

Description

This function updates the hash with the data provided.

Remarks

In order to preserve the validity of the SHA384 hash, nothing must modify the context holding variable between calls to CRYPT_SHA384_DataAdd.

Preconditions

The SHA384 context must be initialized prior to the first call of this function. The context must not be modified by code outside of this function.

Example

```
CRYPT_SHA384_CTX sha384;
uint8_t buffer[1024];
uint8_t shaSum[SHA384_DIGEST_SIZE];

CRYPT_SHA384_Initialize(&sha384);
CRYPT_SHA384_DataAdd(&sha384, buffer, sizeof(buffer));
CRYPT_SHA384_Finalize(&sha384, shaSum);
```

Parameters

Parameters	Description
sha384	Pointer to CRYPT_SHA384_CTX structure which holds the hash values.
sz	Size of the data (in bytes) of the data to use to update the hash.

Function

```
int CRYPT_SHA384_DataAdd( CRYPT_SHA384_CTX* sha384, const unsigned char* input, unsigned int sz)
```

CRYPT_SHA384_Finalize Function

Finalizes the hash and puts the result into digest.

File

[crypto.h](#)

C

```
int CRYPT_SHA384_Finalize(CRYPT_SHA384_CTX*, unsigned char*);
```

Returns

- BAD_FUNC_ARG - An invalid pointer was passed to the function, either in sha384 or digest.
- 0 - An invalid pointer was not passed to the function.

Description

This function finalizes the hash and puts the result into digest.

Remarks

In order to preserve the validity of the SHA384 hash, nothing must modify the context holding variable between calls to [CRYPT_SHA384_DataAdd](#) and [CRYPT_SHA384_Finalize](#).

Preconditions

The SHA384 context must be initialized prior to calling this function. The context must not be modified by code outside of this function.

Example

```
CRYPT_SHA384_CTX sha384;
uint8_t buffer[1024];
uint8_t shaSum[SHA384_DIGEST_SIZE];

CRYPT_SHA384_Initialize(&sha384);
CRYPT_SHA384_DataAdd(&sha384, buffer, sizeof(buffer));
CRYPT_SHA384_Finalize(&sha384, shaSum);
```

Parameters

Parameters	Description
sha384	Pointer to CRYPT_SHA384_CTX structure which holds the hash values.
digest	Pointer to byte array to store hash result.

Function

int CRYPT_SHA384_Finalize([CRYPT_SHA384_CTX*](#) sha384, unsigned char* digest)

CRYPT_SHA384_Initialize Function

Initializes the internal structures necessary for SHA384 hash calculations.

File

[crypto.h](#)

C

```
int CRYPT_SHA384_Initialize(CRYPT_SHA384_CTX*);
```

Returns

- BAD_FUNC_ARG - An invalid pointer was passed to the function
- 0 - An invalid pointer was not passed to the function

Description

This function initializes the internal structures necessary for SHA384 hash calculations.

Remarks

All SHA384 hashes have to start at a particular value before adding new data to it. This function sets the necessary values for the structure.

Preconditions

None.

Example

```
CRYPT_SHA384_CTX sha384;
uint8_t shaSum[SHA384_DIGEST_SIZE];

CRYPT_SHA384_Initialize(&sha384);
CRYPT_SHA384_DataAdd(&sha384, buffer, sizeof(buffer));
CRYPT_SHA384_Finalize(&sha384, shaSum);
```

Parameters

Parameters	Description
sha384	Pointer to CRYPT_SHA384_CTX structure which holds the hash values.

Function

int CRYPT_SHA384_Initialize([CRYPT_SHA384_CTX*](#) sha384)

m) SHA512 Hash Functions

CRYPT_SHA512_DataAdd Function

Updates the hash with the data provided.

File

[crypto.h](#)

C

```
int CRYPT_SHA512_DataAdd(CRYPT_SHA512_CTX*, const unsigned char*, unsigned int);
```

Returns

- BAD_FUNC_ARG - An invalid pointer was passed to the function, either in sha512 or input.
- 0 - An invalid pointer was not passed to the function.

Description

This function updates the hash with the data provided.

Remarks

In order to preserve the validity of the SHA512 hash, nothing must modify the context holding variable between calls to CRYPT_SHA512_DataAdd.

Preconditions

The SHA512 context must be initialized prior to the first call of this function. The context must not be modified by code outside of this function.

Example

```
CRYPT_SHA512_CTX sha512;
uint8_t buffer[1024];
uint8_t sha512Sum[SHA512_DIGEST_SIZE];

CRYPT_SHA512_Initialize(&sha512);
CRYPT_SHA512_DataAdd(&sha512, buffer, sizeof(buffer));
CRYPT_SHA512_Finalize(&sha512, sha512Sum);
```

Parameters

Parameters	Description
sha512	Pointer to CRYPT_SHA512_CTX structure which holds the hash values.
sz	Size of the data (in bytes) of the data to use to update the hash.

Function

```
int CRYPT_SHA512_DataAdd( CRYPT_SHA512_CTX* sha512, const unsigned char* input, unsigned int sz)
```

CRYPT_SHA512_Finalize Function

Finalizes the hash and puts the result into digest.

File

[crypto.h](#)

C

```
int CRYPT_SHA512_Finalize(CRYPT_SHA512_CTX*, unsigned char*);
```

Returns

- BAD_FUNC_ARG - An invalid pointer was passed to the function, either in sha512 or digest.
- 0 - An invalid pointer was not passed to the function.

Description

This function finalizes the hash and puts the result into digest.

Remarks

In order to preserve the validity of the SHA512 hash, nothing must modify the context holding variable between calls to [CRYPT_SHA512_DataAdd](#) and [CRYPT_SHA512_Finalize](#).

Preconditions

The SHA512 context must be initialized prior to calling this function. The context must not be modified by code outside of this function.

Example

```
CRYPT_SHA512_CTX sha512;
uint8_t buffer[1024];
uint8_t sha512Sum[SHA512_DIGEST_SIZE];

CRYPT_SHA512_Initialize(&sha512);
CRYPT_SHA512_DataAdd(&sha512, buffer, sizeof(buffer));
CRYPT_SHA512_Finalize(&sha512, sha512Sum);
```

Parameters

Parameters	Description
sha512	Pointer to CRYPT_SHA512_CTX structure which holds the hash values.
digest	Pointer to byte array to store hash result.

Function

int CRYPT_SHA512_Finalize([CRYPT_SHA512_CTX*](#) sha512, unsigned char* digest)

CRYPT_SHA512_Initialize Function

Initializes the internal structures necessary for SHA512 hash calculations.

File

[crypto.h](#)

C

```
int CRYPT_SHA512_Initialize(CRYPT_SHA512_CTX*);
```

Returns

- BAD_FUNC_ARG - An invalid pointer was passed to the function.
- 0 - An invalid pointer was not passed to the function.

Description

This function initializes the internal structures necessary for SHA512 hash calculations.

Remarks

All SHA512 hashes have to start at a particular value before adding new data to it. This function sets the necessary values for the structure.

Preconditions

None.

Example

```
CRYPT_SHA512_CTX sha512;
uint8_t sha512Sum[SHA512_DIGEST_SIZE];

CRYPT_SHA512_Initialize(&sha512);
CRYPT_SHA512_DataAdd(&sha512, buffer, sizeof(buffer));
CRYPT_SHA512_Finalize(&sha512, sha512Sum);
```

Parameters

Parameters	Description
sha512	Pointer to CRYPT_SHA512_CTX structure which holds the hash values.

Function

int CRYPT_SHA512_Initialize([CRYPT_SHA512_CTX*](#) sha512)

n) Data Types and Constants

CRYPT_AES_CTX Structure

File

[crypto.h](#)

C

```
struct CRYPT_AES_CTX {
    int holder[90];
};
```

Members

Members	Description
int holder[90];	big enough to hold internal, but check on init

Description

AES

CRYPT_ECC_CTX Structure

File

[crypto.h](#)

C

```
struct CRYPT_ECC_CTX {
    void* holder;
};
```

Description

ECC

CRYPT_HMAC_CTX Structure

File

[crypto.h](#)

C

```
struct CRYPT_HMAC_CTX {
    long long holder[80];
};
```

Members

Members	Description
long long holder[80];	big enough to hold internal, but check on init

Description

HMAC

CRYPT_MD5_CTX Structure

File

[crypto.h](#)

C

```
struct CRYPT_MD5_CTX {
    int holder[110];
};
```

Members

Members	Description
int holder[110];	big enough to hold internal, but check on init

Description

MD5

CRYPT_RNG_CTX Structure

File

[crypto.h](#)

C

```

struct CRYPT_RNG_CTX {
    int holder[66];
};

```

Members

Members	Description
int holder[66];	big enough to hold internal, but check on init

Description

RNG

CRYPT_RSA_CTX Structure**File**

[crypto.h](#)

C

```

struct CRYPT_RSA_CTX {
    void* holder;
};

```

Description

RSA

CRYPT_SHA_CTX Structure**File**

[crypto.h](#)

C

```

struct CRYPT_SHA_CTX {
    int holder[110];
};

```

Members

Members	Description
int holder[110];	big enough to hold internal, but check on init

Description

SHA

CRYPT_SHA256_CTX Structure**File**

[crypto.h](#)

C

```

struct CRYPT_SHA256_CTX {
    int holder[110];
};

```

Members

Members	Description
int holder[110];	big enough to hold internal, but check on init

Description

SHA-256

CRYPT_SHA384_CTX Structure

File

[crypto.h](#)

C

```
struct CRYPT_SHA384_CTX {
    long long holder[32];
};
```

Members

Members	Description
long long holder[32];	big enough to hold internal, but check on init

Description

SHA-384

CRYPT_SHA512_CTX Structure

File

[crypto.h](#)

C

```
struct CRYPT_SHA512_CTX {
    long long holder[36];
};
```

Members

Members	Description
long long holder[36];	big enough to hold internal, but check on init

Description

SHA-512

CRYPT_TDES_CTX Structure

File

[crypto.h](#)

C

```
struct CRYPT_TDES_CTX {
    int holder[104];
};
```

Members

Members	Description
int holder[104];	big enough to hold internal, but check on init

Description

TDES

MC_CRYPT_API_H Macro

File

[crypto.h](#)

C

```
#define MC_CRYPT_API_H
```

Description

Defines Microchip CRYPTO API layer

Files

Files

Name	Description
crypto.h	Crypto Framework Library header for cryptographic functions.

Description



















This section lists the source and header files used by the Crypto Library.

crypto.h

Crypto Framework Library header for cryptographic functions.

Functions











	Name	Description
⇒	CRYPT_AES_CBC_Decrypt	Performs AES decryption using Cipher-Block-Chaining (CBC).
⇒	CRYPT_AES_CBC_Encrypt	Performs AES encryption using Cipher-Block-Chaining (CBC).
⇒	CRYPT_AES_CTR_Encrypt	Performs AES encryption using Counter (CTR).
⇒	CRYPT_AES_DIRECT_Decrypt	Directs decryption of one block of data.
⇒	CRYPT_AES_DIRECT_Encrypt	Directs encryption of one block of data.
⇒	CRYPT_AES_IvSet	Sets the initialization vector (IV) for AES processing.
⇒	CRYPT_AES_KeySet	Sets the key and initialization vector (IV) for AES processing.
⇒	CRYPT_ECC_DHE_KeyMake	Creates a new ECC key.
⇒	CRYPT_ECC_DHE_SharedSecretMake	Creates an ECC shared secret between two keys.
⇒	CRYPT_ECC_DSA_HashSign	Signs a message digest.
⇒	CRYPT_ECC_DSA_HashVerify	Verifies an ECC signature.
⇒	CRYPT_ECC_Free	Cleans up an Elliptic Curve Cryptography (ECC) Context.
⇒	CRYPT_ECC_Initialize	Initializes the context for Elliptic Curve Cryptography (ECC).
⇒	CRYPT_ECC_KeySizeGet	Returns the key size in octets.
⇒	CRYPT_ECC_PrivateImport	Imports private key pair in X9.63 format.
⇒	CRYPT_ECC_PublicExport	Exports public ECC key in ANSI X9.63 format.
⇒	CRYPT_ECC_PublicImport	Imports public key in ANSI X9.63 format.
⇒	CRYPT_ECC_SignatureSizeGet	Returns the signature size in octets.
⇒	CRYPT_ERROR_StringGet	Reports the nature of an error.
⇒	CRYPT_HMAC_DataAdd	Adds data to the HMAC calculation.
⇒	CRYPT_HMAC_Finalize	Completes the HMAC calculation and get the results.
⇒	CRYPT_HMAC_SetKey	Initializes the HMAC context and set the key for the hash.
⇒	CRYPT_HUFFMAN_Compress	Compresses a block of data.
⇒	CRYPT_HUFFMAN_DeCompress	Decompresses a block of data.
⇒	CRYPT_MD5_DataAdd	Updates the hash with the data provided.
⇒	CRYPT_MD5_DataSizeSet	For PIC32MZ hardware encryption, sets the size of the input data.
⇒	CRYPT_MD5_Finalize	Finalizes the hash and puts the result into digest.
⇒	CRYPT_MD5_Initialize	Initializes the internal structures necessary for MD5 hash calculations.
⇒	CRYPT_RNG_BlockGenerate	Creates several random numbers.
⇒	CRYPT_RNG_Get	Gets one random number.
⇒	CRYPT_RNG_Initialize	Initializes the random number generator.
⇒	CRYPT_RSA_EncryptSizeGet	Gets the size of the RSA Key.
⇒	CRYPT_RSA_Free	Releases the memory used for the key and clean up the context.
⇒	CRYPT_RSA_Initialize	Initializes the internal structures necessary for RSA processing.
⇒	CRYPT_RSA_PrivateDecrypt	Decrypts data using a private key.
⇒	CRYPT_RSA_PrivateKeyDecode	Constructs the Private Key from a DER certificate.
⇒	CRYPT_RSA_PublicEncrypt	Encrypts data using a public key.

	CRYPT_RSA_PublicKeyDecode	Constructs the Public Key from a DER certificate.
	CRYPT_SHA_DataAdd	Updates the hash with the data provided.
	CRYPT_SHA_DataSizeSet	For PIC32MZ hardware encryption, sets the size of the input data.
	CRYPT_SHA_Finalize	Finalizes the hash and puts the result into digest.
	CRYPT_SHA_Initialize	Initializes the internal structures necessary for SHA hash calculations.
	CRYPT_SHA256_DataAdd	Updates the hash with the data provided.
	CRYPT_SHA256_DataSizeSet	For PIC32MZ hardware encryption, sets the size of the input data.
	CRYPT_SHA256_Finalize	Finalizes the hash and puts the result into digest.
	CRYPT_SHA256_Initialize	Initializes the internal structures necessary for SHA256 hash calculations.
	CRYPT_SHA384_DataAdd	Updates the hash with the data provided.
	CRYPT_SHA384_Finalize	Finalizes the hash and puts the result into digest.
	CRYPT_SHA384_Initialize	Initializes the internal structures necessary for SHA384 hash calculations.
	CRYPT_SHA512_DataAdd	Updates the hash with the data provided.
	CRYPT_SHA512_Finalize	Finalizes the hash and puts the result into digest.
	CRYPT_SHA512_Initialize	Initializes the internal structures necessary for SHA512 hash calculations.
	CRYPT_TDES_CBC_Decrypt	Decrypts a data block using Triple DES.
	CRYPT_TDES_CBC_Encrypt	Encrypts a data block using Triple DES.
	CRYPT_TDES_IvSet	Sets the Initialization Vector (IV) for a Triple DES operation.
	CRYPT_TDES_KeySet	Initialization of Triple DES context.

Macros

	Name	Description
	MC_CRYPT_API_H	Defines Microchip CRYPTO API layer

Structures

	Name	Description
	CRYPT_AES_CTX	AES
	CRYPT_ECC_CTX	ECC
	CRYPT_HMAC_CTX	HMAC
	CRYPT_MD5_CTX	MD5
	CRYPT_RNG_CTX	RNG
	CRYPT_RSA_CTX	RSA
	CRYPT_SHA_CTX	SHA
	CRYPT_SHA256_CTX	SHA-256
	CRYPT_SHA384_CTX	SHA-384
	CRYPT_SHA512_CTX	SHA-512
	CRYPT_TDES_CTX	TDES

Description

Crypto Framework Library Header

This header file contains function prototypes and definitions of the data types and constants that make up the Cryptographic Framework Library for PIC32 families of Microchip microcontrollers.

File Name

crypto.h

Company

Microchip Technology Inc.

Index

A

Abstraction Model 3
 Crypto Library 3

B

Building the Library 4
 Crypto Library 4

C

Configuring the Library 4
 Crypto Library 4
 CRYPT_AES_CBC_Decrypt function 14
 CRYPT_AES_CBC_Encrypt function 15
 CRYPT_AES_CTR_Encrypt function 15
 CRYPT_AES_CTX structure 46
 CRYPT_AES_DIRECT_Decrypt function 16
 CRYPT_AES_DIRECT_Encrypt function 17
 CRYPT_AES_IvSet function 18
 CRYPT_AES_KeySet function 18
 CRYPT_ECC_CTX structure 47
 CRYPT_ECC_DHE_KeyMake function 19
 CRYPT_ECC_DHE_SharedSecretMake function 20
 CRYPT_ECC_DSA_HashSign function 21
 CRYPT_ECC_DSA_HashVerify function 21
 CRYPT_ECC_Free function 22
 CRYPT_ECC_Initialize function 23
 CRYPT_ECC_KeySizeGet function 23
 CRYPT_ECC_PrivateImport function 24
 CRYPT_ECC_PublicExport function 25
 CRYPT_ECC_PublicImport function 25
 CRYPT_ECC_SignatureSizeGet function 26
 CRYPT_ERROR_StringGet function 8
 CRYPT_HMAC_CTX structure 47
 CRYPT_HMAC_DataAdd function 35
 CRYPT_HMAC_Finalize function 36
 CRYPT_HMAC_SetKey function 36
 CRYPT_HUFFMAN_Compress function 8
 CRYPT_HUFFMAN_DeCompress function 9
 CRYPT_MD5_CTX structure 47
 CRYPT_MD5_DataAdd function 10
 CRYPT_MD5_DataSizeSet function 12
 CRYPT_MD5_Finalize function 11
 CRYPT_MD5_Initialize function 11
 CRYPT_RNG_BlockGenerate function 13
 CRYPT_RNG_CTX structure 47
 CRYPT_RNG_Get function 13
 CRYPT_RNG_Initialize function 7
 CRYPT_RSA_CTX structure 48
 CRYPT_RSA_EncryptSizeGet function 27
 CRYPT_RSA_Free function 27
 CRYPT_RSA_Initialize function 28
 CRYPT_RSA_PrivateDecrypt function 29
 CRYPT_RSA_PrivateKeyDecode function 29
 CRYPT_RSA_PublicEncrypt function 30
 CRYPT_RSA_PublicKeyDecode function 31
 CRYPT_SHA_CTX structure 48

CRYPT_SHA_DataAdd function 37
 CRYPT_SHA_DataSizeSet function 39
 CRYPT_SHA_Finalize function 38
 CRYPT_SHA_Initialize function 38
 CRYPT_SHA256_CTX structure 48
 CRYPT_SHA256_DataAdd function 40
 CRYPT_SHA256_DataSizeSet function 42
 CRYPT_SHA256_Finalize function 40
 CRYPT_SHA256_Initialize function 41
 CRYPT_SHA384_CTX structure 49
 CRYPT_SHA384_DataAdd function 42
 CRYPT_SHA384_Finalize function 43
 CRYPT_SHA384_Initialize function 44
 CRYPT_SHA512_CTX structure 49
 CRYPT_SHA512_DataAdd function 44
 CRYPT_SHA512_Finalize function 45
 CRYPT_SHA512_Initialize function 46
 CRYPT_TDES_CBC_Decrypt function 32
 CRYPT_TDES_CBC_Encrypt function 32
 CRYPT_TDES_CTX structure 49
 CRYPT_TDES_IvSet function 33
 CRYPT_TDES_KeySet function 34
 Crypto Library Help 3
 crypto.h 50

F

Files 50
 Crypto Library 50

I

Introduction 3

L

Library Interface 5
 Crypto Library 5
 Library Overview 4
 Crypto Library 4

M

MC_CRYPT_API_H macro 49

U

Using the Library 3
 Crypto Library 3

V

Volume V: MPLAB Harmony Framework Reference 2