



**MCP1631**  
**Multi-Chemistry**  
**Battery Charger**  
**Reference Design**

---

---

**Note the following details of the code protection feature on Microchip devices:**

- Microchip products meet the specification contained in their particular Microchip Data Sheet.
- Microchip believes that its family of products is one of the most secure families of its kind on the market today, when used in the intended manner and under normal conditions.
- There are dishonest and possibly illegal methods used to breach the code protection feature. All of these methods, to our knowledge, require using the Microchip products in a manner outside the operating specifications contained in Microchip's Data Sheets. Most likely, the person doing so is engaged in theft of intellectual property.
- Microchip is willing to work with the customer who is concerned about the integrity of their code.
- Neither Microchip nor any other semiconductor manufacturer can guarantee the security of their code. Code protection does not mean that we are guaranteeing the product as "unbreakable."

Code protection is constantly evolving. We at Microchip are committed to continuously improving the code protection features of our products. Attempts to break Microchip's code protection feature may be a violation of the Digital Millennium Copyright Act. If such acts allow unauthorized access to your software or other copyrighted work, you may have a right to sue for relief under that Act.

Information contained in this publication regarding device applications and the like is provided only for your convenience and may be superseded by updates. It is your responsibility to ensure that your application meets with your specifications. MICROCHIP MAKES NO REPRESENTATIONS OR WARRANTIES OF ANY KIND WHETHER EXPRESS OR IMPLIED, WRITTEN OR ORAL, STATUTORY OR OTHERWISE, RELATED TO THE INFORMATION, INCLUDING BUT NOT LIMITED TO ITS CONDITION, QUALITY, PERFORMANCE, MERCHANTABILITY OR FITNESS FOR PURPOSE. Microchip disclaims all liability arising from this information and its use. Use of Microchip devices in life support and/or safety applications is entirely at the buyer's risk, and the buyer agrees to defend, indemnify and hold harmless Microchip from any and all damages, claims, suits, or expenses resulting from such use. No licenses are conveyed, implicitly or otherwise, under any Microchip intellectual property rights.

**Trademarks**

The Microchip name and logo, the Microchip logo, Accuron, dsPIC, KEELOQ, KEELOQ logo, microID, MPLAB, PIC, PICmicro, PICSTART, PRO MATE, rPIC and SmartShunt are registered trademarks of Microchip Technology Incorporated in the U.S.A. and other countries.

AmpLab, FilterLab, Linear Active Thermistor, Migratable Memory, MXDEV, MXLAB, SEEVAL, SmartSensor and The Embedded Control Solutions Company are registered trademarks of Microchip Technology Incorporated in the U.S.A.

Analog-for-the-Digital Age, Application Maestro, CodeGuard, dsPICDEM, dsPICDEM.net, dsPICworks, dsSPEAK, ECAN, ECONOMONITOR, FanSense, FlexROM, fuzzyLAB, In-Circuit Serial Programming, ICSP, ICEPIC, Mindi, MiWi, MPASM, MPLAB Certified logo, MPLIB, MPLINK, PCKit, PICDEM, PICDEM.net, PICLAB, PICTail, PowerCal, PowerInfo, PowerMate, PowerTool, REAL ICE, rfLAB, Select Mode, Smart Serial, SmartTel, Total Endurance, UNI/O, WiperLock and ZENA are trademarks of Microchip Technology Incorporated in the U.S.A. and other countries.

SQTP is a service mark of Microchip Technology Incorporated in the U.S.A.

All other trademarks mentioned herein are property of their respective companies.

© 2007, Microchip Technology Incorporated, Printed in the U.S.A., All Rights Reserved.

 Printed on recycled paper.

**QUALITY MANAGEMENT SYSTEM  
CERTIFIED BY DNV  
== ISO/TS 16949:2002 ==**

*Microchip received ISO/TS-16949:2002 certification for its worldwide headquarters, design and wafer fabrication facilities in Chandler and Tempe, Arizona; Gresham, Oregon and design centers in California and India. The Company's quality system processes and procedures are for its PIC® MCUs and dsPIC® DSCs, KEELOQ® code hopping devices, Serial EEPROMs, microperipherals, nonvolatile memory and analog products. In addition, Microchip's quality system for the design and manufacture of development systems is ISO 9001:2000 certified.*



# MCP1631 MULTI-CHEMISTRY BATTERY CHARGER REFERENCE DESIGN

---

---

## Table of Contents

---

---

<b>Preface</b> .....	<b>1</b>
Introduction.....	1
Document Layout .....	1
Conventions Used in this Guide .....	2
Recommended Reading.....	3
The Microchip Web Site .....	3
Customer Support .....	3
Document Revision History .....	3
<b>Chapter 1. Product Overview</b>	
1.1 Introduction .....	5
1.2 What is the MCP1631 Multi-Chemistry Battery Charger Reference Design? .....	6
1.3 What the MCP1631 Multi-Chemistry Battery Charger Reference Design Kit includes .....	6
<b>Chapter 2. Installation and Operation</b>	
2.1 Introduction .....	7
2.2 Features .....	7
2.3 Getting Started .....	8
<b>Appendix A. Schematic and Layouts</b>	
A.1 Introduction .....	13
A.2 Board – Schematic .....	14
A.3 Board – Top Silk Layer .....	15
A.4 Board – Top Metal Layer .....	16
A.5 Board – Mid1 Metal Layer .....	17
A.6 Board – Mid2 Metal Layer .....	18
A.7 Board – Bottom Metal Layer .....	19
<b>Appendix B. Bill Of Materials (BOM)</b>	
<b>Appendix C. Demo Board Firmware</b>	
C.1 Device Firmware Flowchart Page 1 .....	23
<b>Worldwide Sales and Service</b> .....	<b>24</b>

# **MCP1631 Multi-Chemistry Battery Charger Reference Design**

---

---

NOTES:



# MCP1631 MULTI-CHEMISTRY BATTERY CHARGER REFERENCE DESIGN

---

---

## Preface

---

---

### NOTICE TO CUSTOMERS

All documentation becomes dated, and this manual is no exception. Microchip tools and documentation are constantly evolving to meet customer needs, so some actual dialogs and/or tool descriptions may differ from those in this document. Please refer to our web site ([www.microchip.com](http://www.microchip.com)) to obtain the latest documentation available.

Documents are identified with a “DS” number. This number is located on the bottom of each page, in front of the page number. The numbering convention for the DS number is “DSXXXXA”, where “XXXX” is the document number and “A” is the revision level of the document.

For the most up-to-date information on development tools, see the MPLAB® IDE on-line help. Select the Help menu, and then Topics to open a list of available on-line help files.

## INTRODUCTION

This chapter contains general information that will be useful to know before using the MCP1631 Multi-Chemistry Battery Charger Reference Design. Items discussed in this chapter include:

- Document Layout
- Conventions Used in this Guide
- Recommended Reading
- The Microchip Web Site
- Customer Support
- Document Revision History

## DOCUMENT LAYOUT

This document describes how to use the MCP1631 Multi-Chemistry Battery Charger Reference Design. The manual layout is as follows:

- **Chapter 1. “Product Overview”** – Important information about the MCP1631 Multi-Chemistry Battery Charger Reference Design.
- **Chapter 2. “Installation and Operation”** – Includes instructions on how to get started with this user’s guide and a description of the user’s guide.
- **Appendix A. “Schematic and Layouts”** – Shows the schematic and layout diagrams for the MCP1631 Multi-Chemistry Battery Charger Reference Design.
- **Appendix B. “Bill Of Materials (BOM)”** – Lists the parts used to build the MCP1631 Multi-Chemistry Battery Charger Reference Design.
- **Appendix C. “Demo Board Firmware”** – Provides information about the application firmware and where the source code can be found.

# MCP1631 Multi-Chemistry Battery Charger Reference Design

## CONVENTIONS USED IN THIS GUIDE

This manual uses the following documentation conventions:

### DOCUMENTATION CONVENTIONS

Description	Represents	Examples
<b>Arial font:</b>		
Italic characters	Referenced books	<i>MPLAB<sup>®</sup> IDE User's Guide</i>
	Emphasized text	...is the <i>only</i> compiler...
Initial caps	A window	the Output window
	A dialog	the Settings dialog
	A menu selection	select Enable Programmer
Quotes	A field name in a window or dialog	"Save project before build"
Underlined, italic text with right angle bracket	A menu path	<u><i>File&gt;Save</i></u>
Bold characters	A dialog button	Click <b>OK</b>
	A tab	Click the <b>Power</b> tab
N'Rnnnn	A number in verilog format, where N is the total number of digits, R is the radix and n is a digit.	4'b0010, 2'hF1
Text in angle brackets < >	A key on the keyboard	Press <Enter>, <F1>
<b>Courier New font:</b>		
Plain Courier New	Sample source code	#define START
	Filenames	autoexec.bat
	File paths	c:\mcc18\h
	Keywords	_asm, _endasm, static
	Command-line options	-Opa+, -Opa-
	Bit values	0, 1
	Constants	0xFF, 'A'
Italic Courier New	A variable argument	<i>file.o</i> , where <i>file</i> can be any valid filename
Square brackets [ ]	Optional arguments	mcc18 [options] <i>file</i> [options]
Curly brackets and pipe character: {   }	Choice of mutually exclusive arguments; an OR selection	errorlevel {0 1}
Ellipses...	Replaces repeated text	var_name [, var_name...]
	Represents code supplied by user	void main (void) { ... }

## RECOMMENDED READING

This user's guide describes how to use MCP1631 Multi-Chemistry Battery Charger Reference Design. The following Microchip documents are available and recommended as supplemental reference resources.

**MCP1631 Data Sheet, “High-Speed, Microcontroller-Adaptable, Pulse Width Modulator”, DS22063**

This data sheet provides detailed information regarding the MCP1631/MCP1631V, MCP1631HV and MCP1631VHV product family.

**PIC16F883 Data Sheet, “8-Pin Flash-Based, 8-Bit CMOS Microcontrollers with Nano Watt Technology”, DS41291**

This data sheet provides detailed information regarding the PIC16F883 product family.

**AN1137 Application Note, “Using the MCP1631 Family to Develop Low-Cost Battery Chargers”, DS01137**

## THE MICROCHIP WEB SITE

Microchip provides online support via our web site at [www.microchip.com](http://www.microchip.com). This web site is used as a means to make files and information easily available to customers. Accessible by using your favorite Internet browser, the web site contains the following information:

- **Product Support** – Data sheets and errata, application notes and sample programs, design resources, user's guides and hardware support documents, latest software releases and archived software
- **General Technical Support** – Frequently Asked Questions (FAQs), technical support requests, online discussion groups, Microchip consultant program member listing
- **Business of Microchip** – Product selector and ordering guides, latest Microchip press releases, listing of seminars and events, listings of Microchip sales offices, distributors and factory representatives

## CUSTOMER SUPPORT

Users of Microchip products can receive assistance through several channels:

- Distributor or Representative
- Local Sales Office
- Field Application Engineer (FAE)
- Technical Support

Customers should contact their distributor, representative or field application engineer (FAE) for support. Local sales offices are also available to help customers. A listing of sales offices and locations is included in the back of this document.

Technical support is available through the web site at: <http://support.microchip.com>

## DOCUMENT REVISION HISTORY

### Revision A (January 2008)

- Initial Release of this Document.

# MCP1631 Multi-Chemistry Battery Charger Reference Design

---

---

NOTES:



## Chapter 1. Product Overview

### 1.1 INTRODUCTION

The MCP1631HV Multi-Chemistry reference design board is used to charge one, two, three or four NiMH batteries or one or two cell Li-Ion batteries. The board uses the MCP1631HV high speed analog PWM and PIC16F883 to generate the charge algorithm for NiMH, NiCd or Li-Ion batteries.

The MCP1631 Multi-Chemistry Battery Charger Reference Design is used to evaluate Microchip's MCP1631HV in a SEPIC power converter application. As provided, the MCP1631 Multi-Chemistry Battery Charger Reference Design is user programmable using on board push buttons. The board can charge NiMH, NiCd or Li-Ion batteries. The MCP1631 Multi-Chemistry Battery Charger Reference Design provides a constant current charge (Ni based chemistry) and constant current / constant voltage (Li-Ion) with preconditioning, cell temperature monitoring (Ni based) and battery pack fault monitoring. Also, the charger provides a status or fault indication. The MCP1631 Multi-Chemistry Battery Charger Reference Design automatically detects the insertion or removal of a battery pack.

This chapter covers the following topics.

- What is the MCP1631 Multi-Chemistry Battery Charger Reference Design?
- What the MCP1631 Multi-Chemistry Battery Charger Reference Design Kit includes.

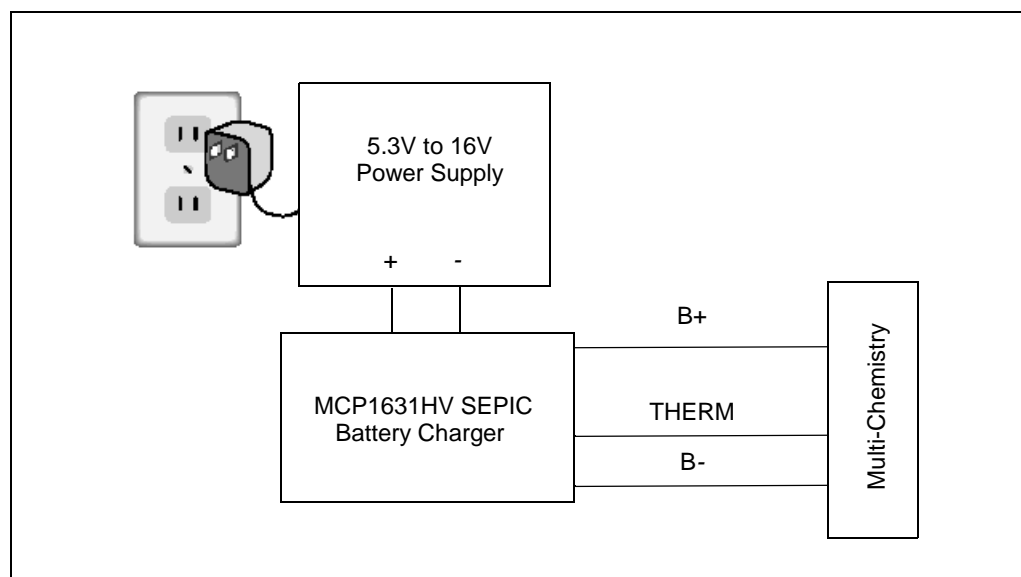

**FIGURE 1-1:** MCP1631 Multi-Chemistry Battery Charger Reference Design Block Diagram.

# MCP1631 Multi-Chemistry Battery Charger Reference Design

## 1.2 WHAT IS THE MCP1631 MULTI-CHEMISTRY BATTERY CHARGER REFERENCE DESIGN?

The MCP1631 Multi-Chemistry Battery Charger Reference Design is a complete stand-alone constant current battery charger for NiMH, NiCd or Li-Ion battery packs. When charging NiMH or NiCd batteries the reference design is capable of charging one, two, three or four batteries connected in series. If Li-Ion chemistry is selected, the board is capable of charging one or two series batteries. This board utilizes Microchip's MCP1631HV (high-speed PIC® MCU PWM TSSOP-20). The input voltage range for the demo board is 5.3V to 16V.

**Note:** For this board,  $V_{IN}$  must be greater than  $V_{OUT}$ , duty cycle is limited to 50%. This can be modified so that  $V_{OUT} = V_{IN}$  or  $V_{OUT} > V_{IN}$  because the SEPIC converter is capable of buck-boost operation.

**TABLE 1-1: MULTI-CHEMISTRY CHARGER CAPABILITY**

Battery Chemistry	1-Cell	2-Cell	3-Cell	4-Cell
Li-Ion	2A	1A	N/A	N/A
NiMH or NiCd	1.5A	1.5A	1.5A	1.5A

An input terminal block is provided to apply the input voltage to the charger. An output header is also provided as a means to connect the external battery pack or simulated battery load and external 10 kΩ thermistor. A programming header is available for updating the firmware contained in the PIC16F883.

## 1.3 WHAT THE MCP1631 MULTI-CHEMISTRY BATTERY CHARGER REFERENCE DESIGN KIT INCLUDES

This MCP1631 Multi-Chemistry Battery Charger Reference Design kit includes:

- The MCP1631 Multi-Chemistry Battery Charger Reference Design Board, 102-00145
- Analog and Interface Products Demonstration Boards CD-ROM (DS21912)
  - MCP1631 Multi-Chemistry Battery Charger Reference Design User's Guide, (DS51697).
  - MCP1631 Data Sheet, "High-Speed, Microcontroller-Adaptable, Pulse Width Modulator", (DS22063).
  - PIC16F883 Data Sheet, "8-Pin Flash-Based, 8-Bit CMOS Microcontrollers with nanoWatt Technology", (DS41291).
  - AN1137, Using the MCP1631 Family to Develop Low-Cost Battery Chargers, (DS01137)

---

---

## Chapter 2. Installation and Operation

---

---

### 2.1 INTRODUCTION

The MCP1631HV Multi-Chemistry Battery Charger demonstrates Microchip's high-speed Pulse Width Modulator (PWM), MCP1631HV, used in a multi-chemistry battery charger application. When used in conjunction with a microcontroller, the MCP1631HV will control the power system duty cycle to provide output voltage or current regulation. The PIC16F883 microcontroller can be used to regulate output voltage or set current, switching frequency and maximum duty cycle. The MCP1631HV generates duty cycle and provides fast overcurrent protection based off various external inputs. External signals include the input oscillator, the reference voltage, the feedback voltage and the current sense. The output signal is a square-wave pulse. The power train used for the MCP1631HV Multi-Chemistry Battery Charger is a Single-Ended Primary Inductive Converter (SEPIC). The MCP1631HV microcontroller is programmable, allowing the user to modify or develop their own firmware routines to further evaluate the MCP1631HV Multi-Chemistry Battery Charger in this application.

### 2.2 FEATURES

The MCP1631HV Multi-Chemistry Battery Charger has the following features:

- Input Operating Voltage Range
  - +5.3V to +16V ( $V_{IN} > V_{BATT}$ )
- Maximum of 2A Charge Current for single cell Li-Ion
- Charge NiMH, NiCd or Li-Ion Chemistries
- Charge 1 or 2 Cell Li-Ion Batteries in Series
- Charge 1 to 4 Cells of NiMH or NiCd Batteries in Series
- Select Chemistry and Cells using push-buttons
- ON/OFF switch
- Charge Status Indication
- Programmable Charge Profile
- OV Shutdown (2.0V / Cell for NiMH/NiCd or 4.4V/Cell for Li-Ion)

# MCP1631 Multi-Chemistry Battery Charger Reference Design

## 2.3 GETTING STARTED

The MCP1631HV Multi-Chemistry Battery Charger is fully assembled and tested for charging one or two series Li-Ion Batteries or one to four series cell NiMH or NiCd batteries. The charge termination for Li-Ion is based a percentage of fast charge current, the charge termination for NiMH is based on a negative voltage change versus time or positive temperature change versus time. This board requires the use of an external voltage source to charge the series connected batteries with a range of +5.3V to +16V input. An external load and thermistor is also required to evaluate the charger reference design.

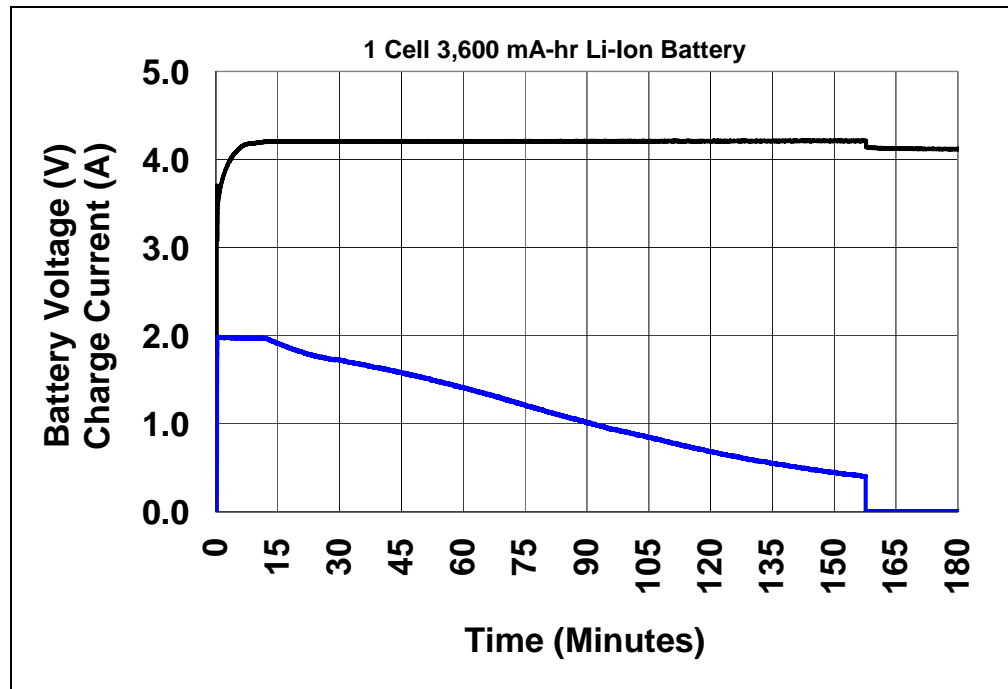

**FIGURE 2-1:** MCP1631HV Multi-Chemistry Battery Charger Charge profile, Li-Ion.

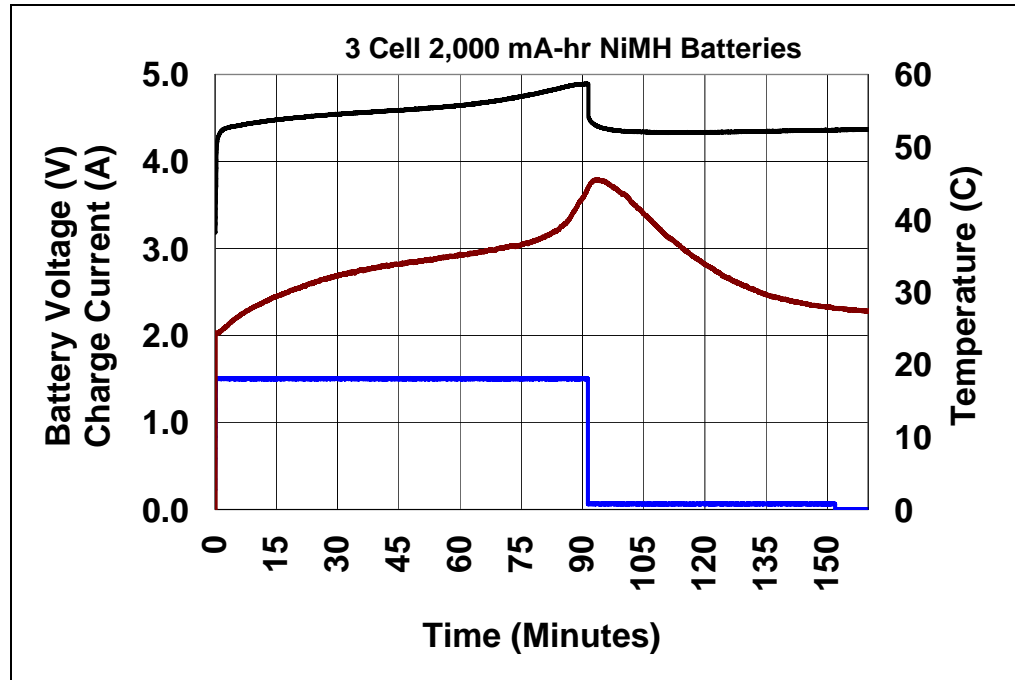

**FIGURE 2-2:** MCP1631HV Multi-Chemistry Battery Charger Charge profile, NiMH/NiCd.

## 2.3.1 Power Input and Output Connection

### 2.3.1.1 POWERING THE MCP1631HV MULTI-CHEMISTRY BATTERY CHARGER

1. Apply the input voltage to the input terminal block, J1. The input voltage source should be limited to the 0V to +16V range. For nominal operation the input voltage should be between +5.3V and +16V.
2. Connect the positive side of the input source (+) to pin 1 of J1. Connect the negative or return side (-) of the input source to pin 2 of J1. Refer to Figure 2-3.



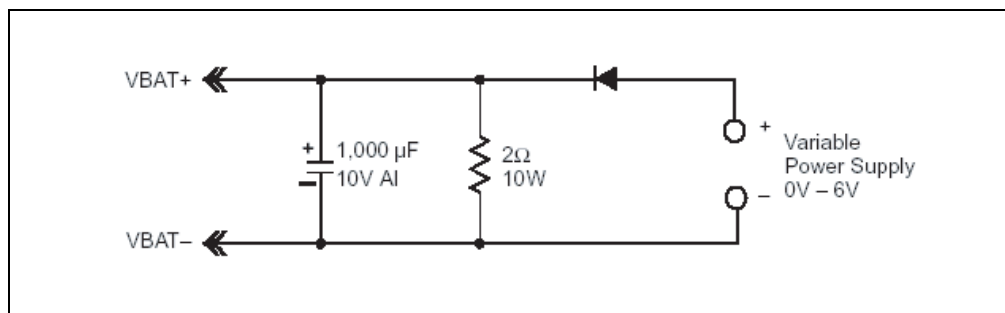

**FIGURE 2-4:** Simulated Battery Load.

### 2.3.1.3 SELECTING BATTERY CHEMISTRY AND NUMBER OF CELLS

2.3.1.3.1 Three push buttons are used to start a charge cycle, select chemistry and select number of series cells. There are two LED's, (green - NiMH, red - Li-Ion) used to indicate chemistry type and four yellow LED's to indicate the number of series cells selected (D6, D7, D8, D9).

2.3.1.3.2 S1 (ON/OFF) is used to start and stop the charge cycle or to enter the programming mode. When the input voltage is within the specified operating range (+5.3V to +16V), press and hold the ON/OFF button for 5 seconds, all LEDs with the exception of D3 should flash. Release S1 and STATUS LED (D3) will be flash, indicating that the board is in programming mode.

1. Press S2 (CHEM) to select the desired chemistry. Indication is provided by a red LED (D4) (Li-Ion) or a green LED (D5) (NiMH/NiCd).
2. Press S3 (CELLS) to select the number of series cells. Indication is provided by yellow (D6 thru D9) (1 Cell to 4 Cell LED's) where D6 = 1 cell, D7 = 2 cell, D8 = 3 cell and D9 = 4 cell.
3. Once the desired chemistry and number of cells is selected, press and release S1 ON/OFF to store the settings. The selected chemistry LED and number of series cells LED both should be illuminated.
4. To start a charge cycle, press and release S1. D3 (green) will be illuminated indicating a charge cycle has begun, the selected chemistry LED should flash slowly indicating normal charge cycle conditions.
5. If the chemistry LED is not flashing and the Status LED is flashing, a fault condition has persisted for 5 attempts indicating that the charge cycle has terminated.
6. Remove the input voltage and check the connections and verify the proper battery pack chemistry and number of series cells.
7. Once the problem is corrected, apply the input voltage, check the chemistry and number of series cells LEDs and press S1 to start a charge cycle.

**Note:** For single cell Li-Ion, a 3,600 mA-Hr. battery with internal protection circuitry is recommended for evaluation. For NiMH charge cycle, Panasonic HHR-210AA/B2B batteries were used to develop the -dV/dt and +dT/dt termination methods.

# MCP1631 Multi-Chemistry Battery Charger Reference Design

---

## 2.3.1.4 STATUS LED

1. The MCP1631HV Multi-Chemistry Battery Charger has an LED to indicate charge status or fault status. Table 2-1 represents the state of the Status LED during various states of the charge cycle.

**TABLE 2-1: STATUS OUTPUT**

Charge Cycle State	LED
Programming	Flashing (Fast)
Qualification	OFF
Preconditioning	ON
Constant Current Fast Charge	ON
Top Off Charge	ON
Charge Complete	OFF
Safety Timer Fault	Flashing (2 Hertz)
Cell Temperature Invalid	Flashing (2 Hertz)
Battery Disconnected	Flashing ( 2 Hertz)
Input Power Removed	OFF

## 2.3.1.5 CHARGE PROFILE

- Li-Ion
  - Qualification: Precharge at 200 mA for  $V_{CELL} < 3.0V$
  - Constant Current = 2A for 1 Cell, 1A for 2 Cell
  - Constant Voltage = 4.20V, Calibrated at board final test
  - Charge Termination = 140 mA for 1 Cell and 2 Cell
  - Overvoltage Detection, once detected, attempt to restart charge cycle 5 times, if overvoltage is persistent, terminate attempts and flash STATUS LED.
- NiMH/NiCd
  - Qualification: Precharge at 200 mA for  $V_{CELL} < 0.9V$
  - Constant Current = 1.5A for 1 Cell to 4 Cell
  - Terminate Fast Charge for  $-dV/dT$  or  $+dT/dt$
  - Timed 50 mA top off charge for 1 hour
  - Overvoltage Detection, once detected, attempt to restart charge cycle 5 times, if overvoltage is persistent, terminate attempts and flash STATUS LED.

## 2.3.1.6 PROGRAMMING

Header J3 is provided for in-system circuit programming.





# MCP1631 MULTI-CHEMISTRY BATTERY CHARGER REFERENCE DESIGN

---

---

## Appendix A. Schematic and Layouts

---

---

### A.1 INTRODUCTION

This appendix contains the following schematics and layouts for the MCP1631 Multi-Chemistry Battery Charger Reference Design:

- Board Schematic
- Board – Top Silk Layer
- Board – Top Metal Layer
- Board – Mid1 Metal Layer
- Board – Mid2 Metal Layer
- Board – Bottom Metal Layer



## A.3 BOARD – TOP SILK LAYER

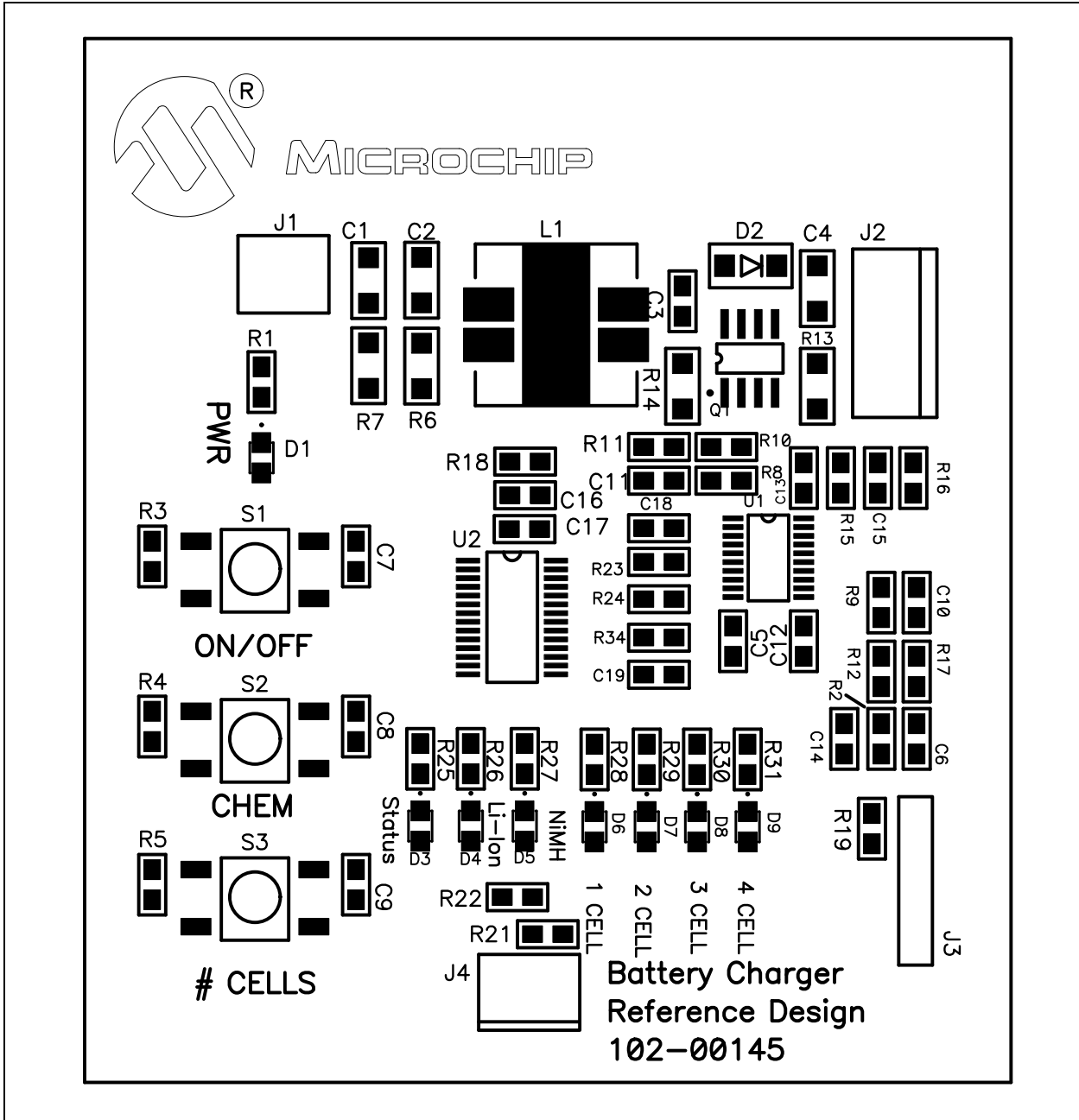

# MCP1631 Multi-Chemistry Battery Charger Reference Design

## A.4 BOARD – TOP METAL LAYER

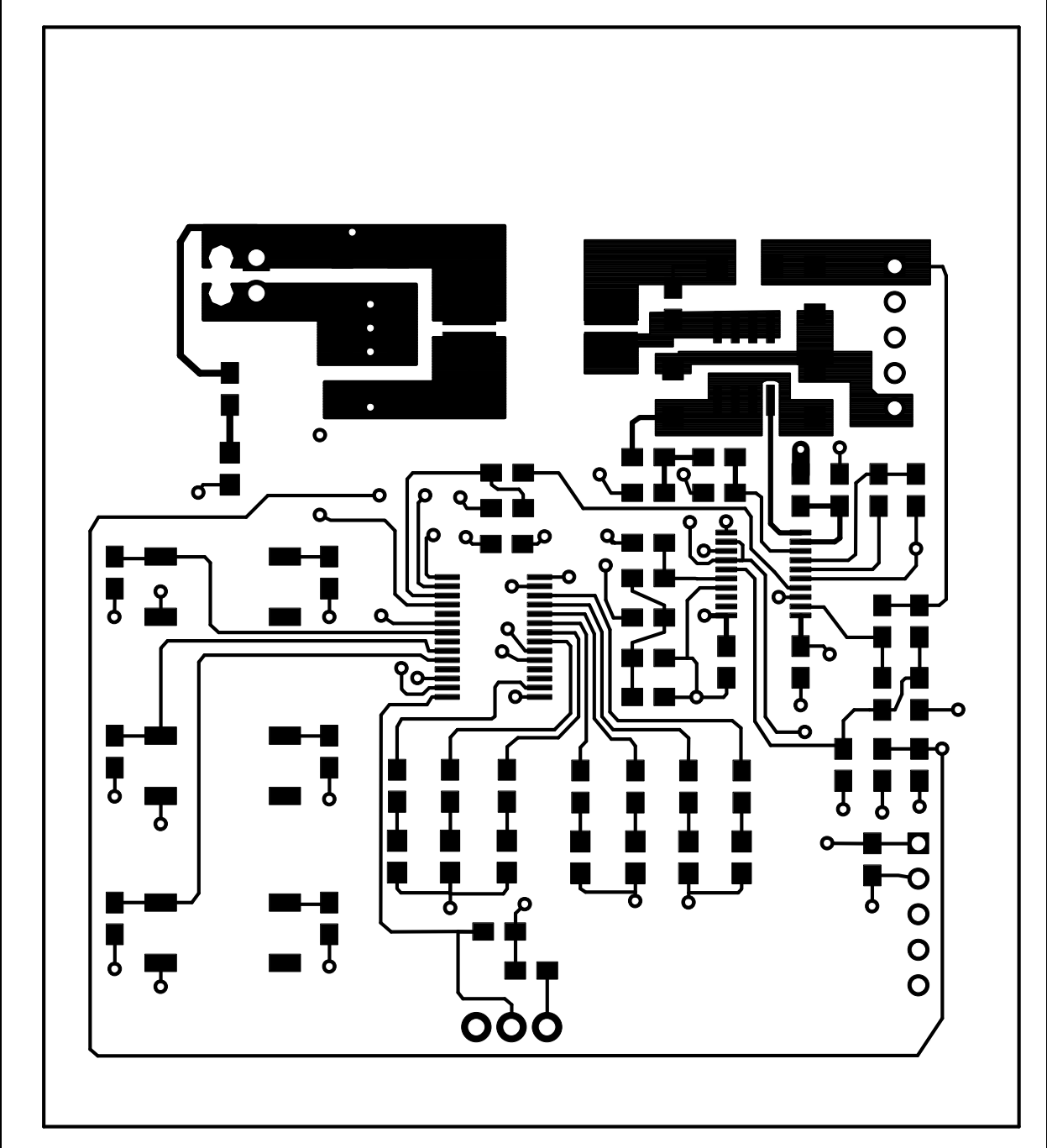

## A.5 BOARD – MID1 METAL LAYER

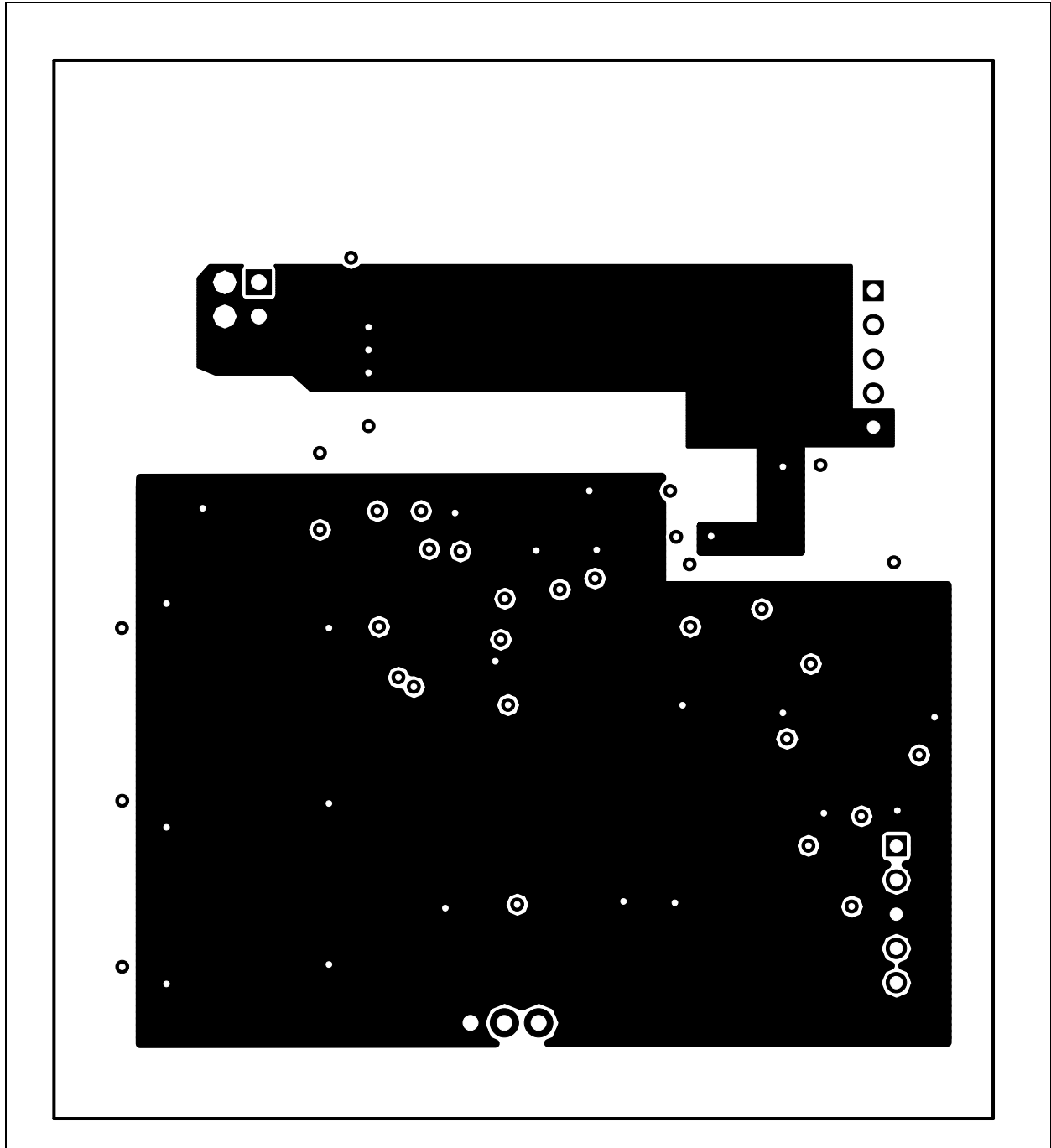

# MCP1631 Multi-Chemistry Battery Charger Reference Design

## A.6 BOARD – MID2 METAL LAYER

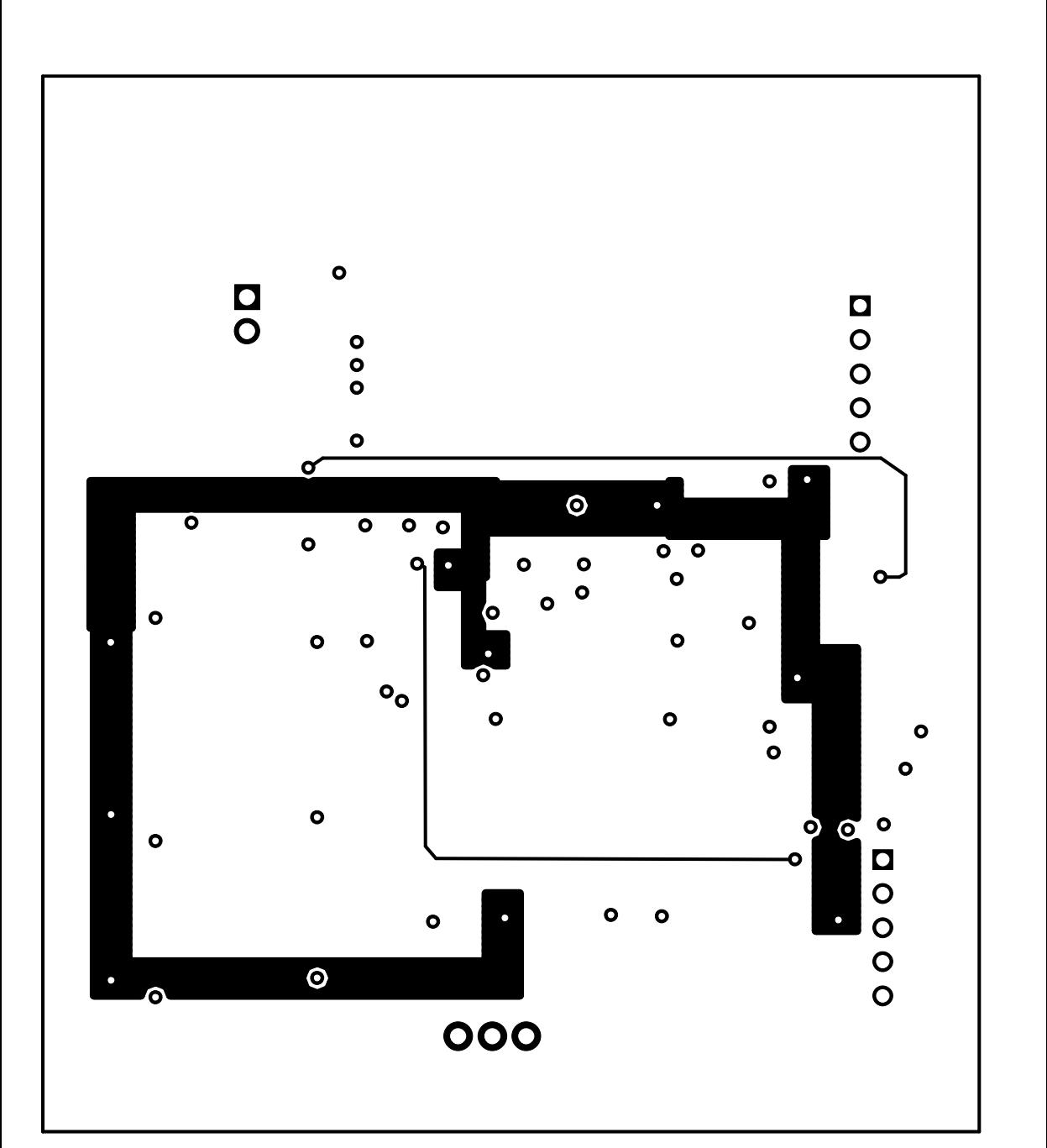

## A.7 BOARD – BOTTOM METAL LAYER

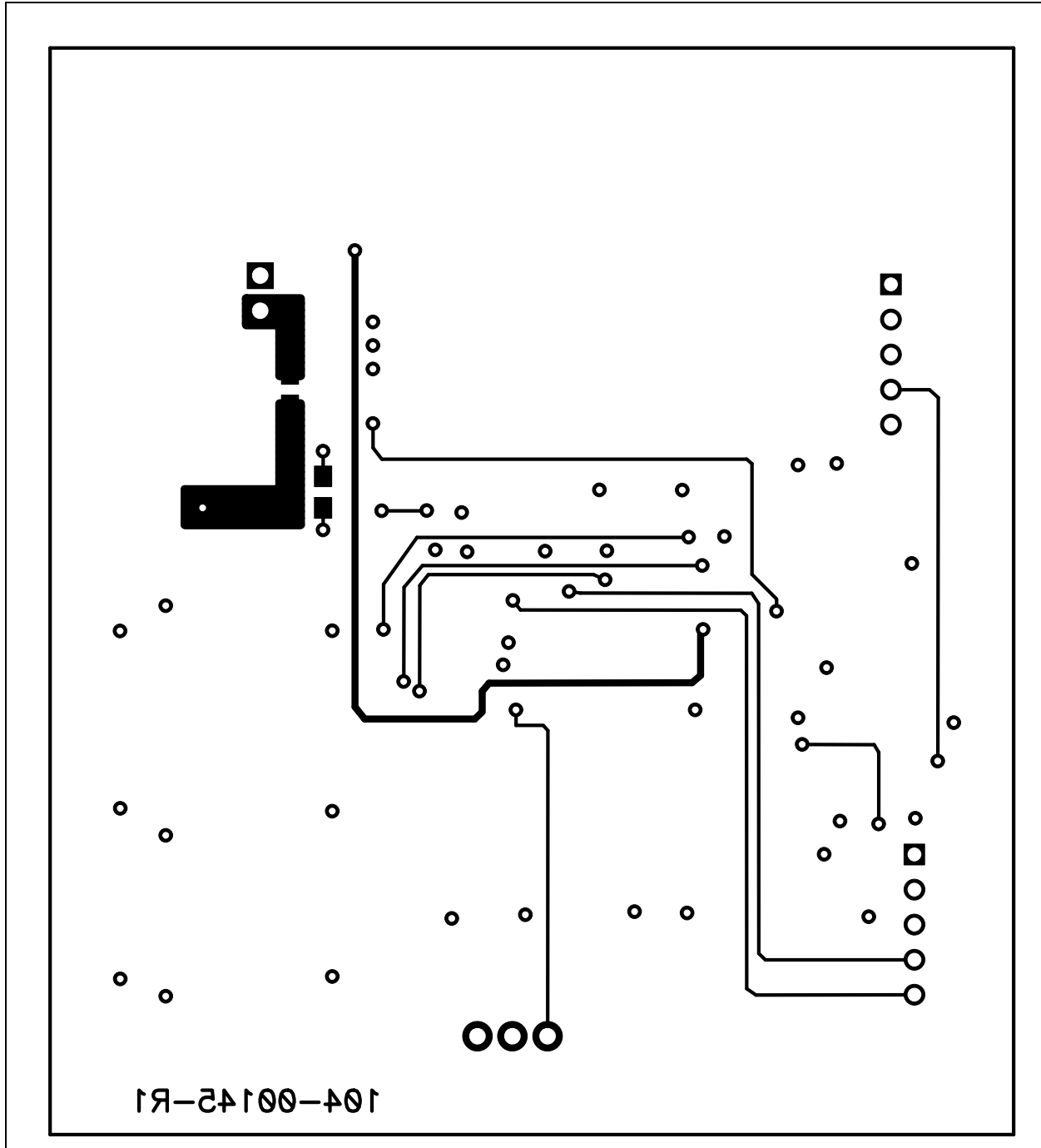

# MCP1631 Multi-Chemistry Battery Charger Reference Design

---

---

NOTES:





# MCP1631 MULTI-CHEMISTRY BATTERY CHARGER REFERENCE DESIGN

## Appendix B. Bill Of Materials (BOM)

TABLE B-1: BILL OF MATERIALS (BOM)

Qty	Reference	Description	Manufacturer	Part Number
3	C1, C2, C4	CAP CERAMIC 10UF 25V X5R 1206	Panasonic® - ECG	ECJ-3YB1E106M
1	C3	CAP CER 2.2UF 25V X7R 0805	Murata Electronics® North America	GRM21BR71E225KA73L
7	C5, C7, C8, C9, C12, C13, C17	CAP CER 1.0UF 25V X7R 0805	Taiyo Yuden®	TMK212BJ105KG-TR
4	C6, C16, C18, C19	CAP .1UF 16V CERAMIC X7R 0805	Panasonic - ECG	ECJ-2VB1C104K
1	C10	DO NOT POPULATE SMT0805 CAPACITOR	—	—
2	C11, C14	CAP 22PF 50V CERM CHIP 0805 SMD	Panasonic - ECG	ECJ-2VC1H220J
1	C15	CAP 1500PF 50V CERM CHIP 0805	Panasonic - ECG	ECJ-2VB1H152K
2	D1, D4	LED 0805 Super RED Clear	Para Light Corp.	L-C170KRCT-U1
1	D2	DIODE SCHOTTKY 30V 3A SMA	Diodes Inc.	B330A-13-F
2	D3, D5	LED 0805 Super Green Clear	Para Light Corp.	L-C170KGCT-U1
4	D6, D7, D8, D9	LED 0805 Super Yellow Clear	Para Light Corp.	L-C170KYCT-U1
1	J1	CONN TERM BLOCK 2.54MM 2POS	Phoenix Contact	1725656
1	J2	CONN HEADER 5POS .100 VERT TIN FRICTION LOCK	Molex® Electronics	22-23-2051
1	J3	CONN HEADER 5POS .100 VERT TIN	Molex Electronics	22-03-2051
1	J4	CONN HEADER 3POS .100 VERT TIN	Molex Electronics	22-23-2031
1	L1	INDUCT/XFRMR SHIELD DL 10UH SMD	Coiltronics/Div of Cooper/Bussmann	DRQ127-100-R
1	PCB	RoHS Compliant Bare PCB, MCP1631 Multi-Chemistry Charger	—	104-00145
1	Q1	HEX/MOS N-CHAN 30V 8.3A 8SOIC	International Rectifier®	IRF7807VTRPBF
3	R1, R10, R11	RES 1.00K OHM 1/8W 1% 0805 SMD	Panasonic - ECG	ERJ-6ENF1001V
3	R2, R18, R19	RES 10.0K OHM 1/8W 1% 0805 SMD	Panasonic - ECG	ERJ-6ENF1002V
7	R3, R4, R5, R16, R21, R22, R23	RES 49.9K OHM 1/8W 1% 0805 SMD	Panasonic - ECG	ERJ-6ENF4992V
4	R6, R7, R13, R14	RES .22 OHM 1/4W 1% 1206 SMD	Panasonic - ECG	ERJ-8RQFR22V
1	R8	RES 20.0K OHM 1/8W 1% 0805 SMD	Panasonic - ECG	ERJ-6ENF2002V
1	R9	RES 348K OHM 1/8W 1% 0805 SMD	Panasonic - ECG	ERJ-6ENF3483V
1	R12	RES 301K OHM 1/8W 1% 0805 SMD	Panasonic - ECG	ERJ-6ENF3013V
1	R15	RES 10.0 OHM 1/8W 1% 0805 SMD	Panasonic - ECG	ERJ-6ENF10R0V

**Note:** The components listed in this Bill Of Materials are representative of the PCB assembly. The released BOM used in manufacturing uses all RoHS-compliant components.

# MCP1631 Multi-Chemistry Battery Charger Reference Design

**TABLE B-1: BILL OF MATERIALS (BOM) (CONTINUED)**

Qty	Reference	Description	Manufacturer	Part Number
1	R17	RES 100K OHM 1/8W 1% 0805 SMD	Panasonic - ECG	ERJ-6ENF1003V
1	R20	DO NOT POPULATE SMT0805 RESISTOR	—	—
1	R24	RES 15.0K OHM 1/8W 1% 0805 SMD	Panasonic - ECG	ERJ-6ENF1502V
7	R25, R26, R27, R28, R29, R30, R31	RES 499 OHM 1/8W 1% 0805 SMD	Panasonic - ECG	ERJ-6ENF4990V
1	R32	RES 0.0 OHM 1/8W 5% 0805 SMD	Panasonic - ECG	ERJ-6GEY0R00V
1	R34	RES 18.2K OHM 1/8W 1% 0805 SMD	Panasonic - ECG	ERJ-6ENF1822V
3	S1, S2, S3	SWITCH TACT 6MM 260GF SMT	E-Switch	TL3301NF260QG
1	U1	MCP1631HV 5.0V 20 Pin TSSOP High Speed PWM	Microchip Technology Inc.	MCP1631HV-500E/ST
1	U2	IC PIC MCU FLASH 4KX14 28SSOP	Microchip Technology Inc.	PIC16F883-I/SS

**Note:** The components listed in this Bill Of Materials are representative of the PCB assembly. The released BOM used in manufacturing uses all RoHS-compliant components.

**Appendix C. Demo Board Firmware**

**C.1 DEVICE FIRMWARE FLOWCHART PAGE 1**

For the latest copy of the MCP1631 Multi-Chemistry Battery Charger Reference Design firmware, visit our web site at [www.microchip.com](http://www.microchip.com).

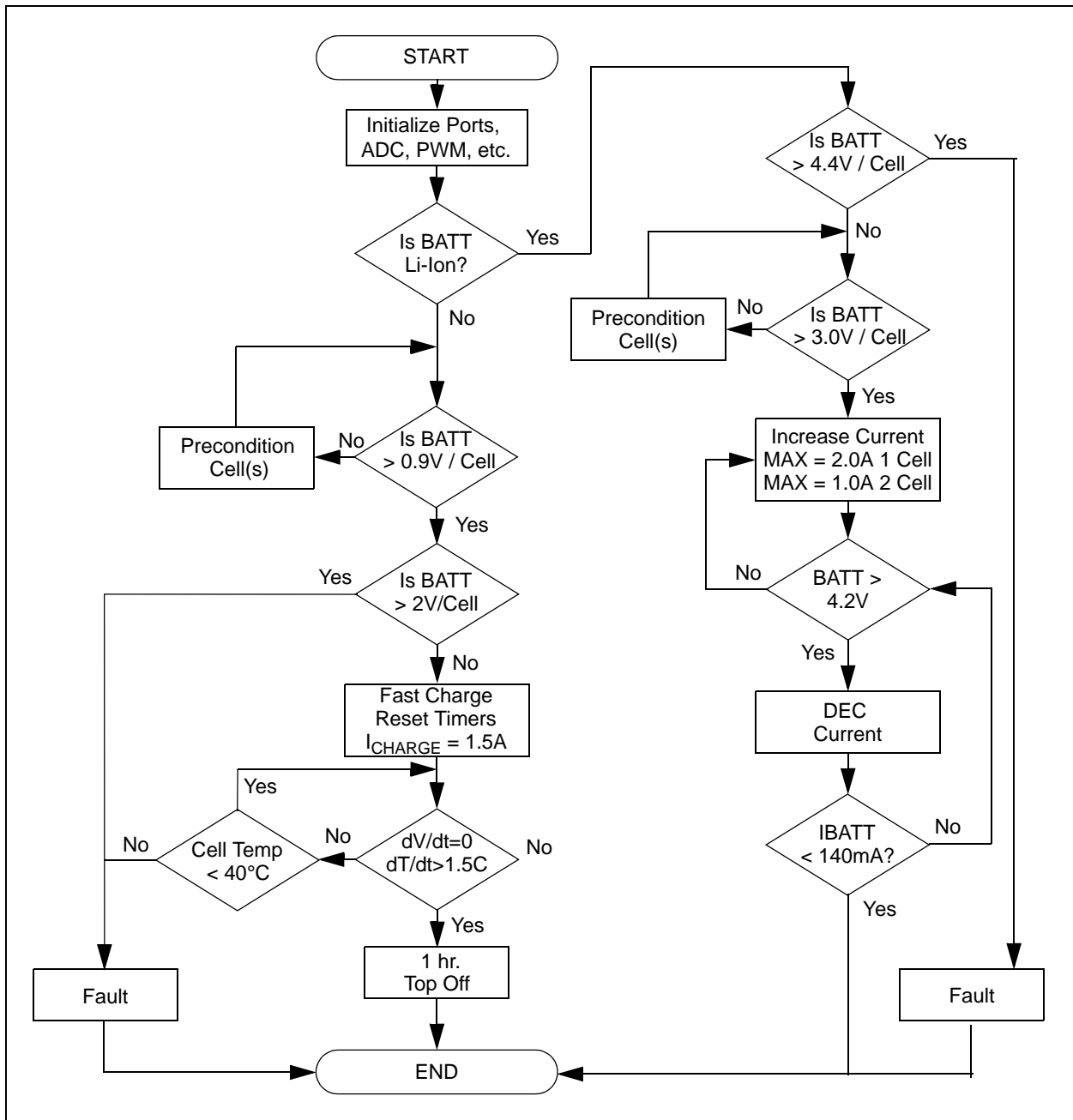

**FIGURE C-1:** Firmware Flowchart.



## WORLDWIDE SALES AND SERVICE

### AMERICAS

**Corporate Office**  
2355 West Chandler Blvd.  
Chandler, AZ 85224-6199  
Tel: 480-792-7200  
Fax: 480-792-7277  
Technical Support:  
<http://support.microchip.com>  
Web Address:  
[www.microchip.com](http://www.microchip.com)

**Atlanta**  
Duluth, GA  
Tel: 678-957-9614  
Fax: 678-957-1455

**Boston**  
Westborough, MA  
Tel: 774-760-0087  
Fax: 774-760-0088

**Chicago**  
Itasca, IL  
Tel: 630-285-0071  
Fax: 630-285-0075

**Dallas**  
Addison, TX  
Tel: 972-818-7423  
Fax: 972-818-2924

**Detroit**  
Farmington Hills, MI  
Tel: 248-538-2250  
Fax: 248-538-2260

**Kokomo**  
Kokomo, IN  
Tel: 765-864-8360  
Fax: 765-864-8387

**Los Angeles**  
Mission Viejo, CA  
Tel: 949-462-9523  
Fax: 949-462-9608

**Santa Clara**  
Santa Clara, CA  
Tel: 408-961-6444  
Fax: 408-961-6445

**Toronto**  
Mississauga, Ontario,  
Canada  
Tel: 905-673-0699  
Fax: 905-673-6509

### ASIA/PACIFIC

**Asia Pacific Office**  
Suites 3707-14, 37th Floor  
Tower 6, The Gateway  
Harbour City, Kowloon  
Hong Kong  
Tel: 852-2401-1200  
Fax: 852-2401-3431

**Australia - Sydney**  
Tel: 61-2-9868-6733  
Fax: 61-2-9868-6755

**China - Beijing**  
Tel: 86-10-8528-2100  
Fax: 86-10-8528-2104

**China - Chengdu**  
Tel: 86-28-8665-5511  
Fax: 86-28-8665-7889

**China - Fuzhou**  
Tel: 86-591-8750-3506  
Fax: 86-591-8750-3521

**China - Hong Kong SAR**  
Tel: 852-2401-1200  
Fax: 852-2401-3431

**China - Nanjing**  
Tel: 86-25-8473-2460  
Fax: 86-25-8473-2470

**China - Qingdao**  
Tel: 86-532-8502-7355  
Fax: 86-532-8502-7205

**China - Shanghai**  
Tel: 86-21-5407-5533  
Fax: 86-21-5407-5066

**China - Shenyang**  
Tel: 86-24-2334-2829  
Fax: 86-24-2334-2393

**China - Shenzhen**  
Tel: 86-755-8203-2660  
Fax: 86-755-8203-1760

**China - Shunde**  
Tel: 86-757-2839-5507  
Fax: 86-757-2839-5571

**China - Wuhan**  
Tel: 86-27-5980-5300  
Fax: 86-27-5980-5118

**China - Xian**  
Tel: 86-29-8833-7252  
Fax: 86-29-8833-7256

### ASIA/PACIFIC

**India - Bangalore**  
Tel: 91-80-4182-8400  
Fax: 91-80-4182-8422

**India - New Delhi**  
Tel: 91-11-4160-8631  
Fax: 91-11-4160-8632

**India - Pune**  
Tel: 91-20-2566-1512  
Fax: 91-20-2566-1513

**Japan - Yokohama**  
Tel: 81-45-471- 6166  
Fax: 81-45-471-6122

**Korea - Daegu**  
Tel: 82-53-744-4301  
Fax: 82-53-744-4302

**Korea - Seoul**  
Tel: 82-2-554-7200  
Fax: 82-2-558-5932 or  
82-2-558-5934

**Malaysia - Kuala Lumpur**  
Tel: 60-3-6201-9857  
Fax: 60-3-6201-9859

**Malaysia - Penang**  
Tel: 60-4-227-8870  
Fax: 60-4-227-4068

**Philippines - Manila**  
Tel: 63-2-634-9065  
Fax: 63-2-634-9069

**Singapore**  
Tel: 65-6334-8870  
Fax: 65-6334-8850

**Taiwan - Hsin Chu**  
Tel: 886-3-572-9526  
Fax: 886-3-572-6459

**Taiwan - Kaohsiung**  
Tel: 886-7-536-4818  
Fax: 886-7-536-4803

**Taiwan - Taipei**  
Tel: 886-2-2500-6610  
Fax: 886-2-2508-0102

**Thailand - Bangkok**  
Tel: 66-2-694-1351  
Fax: 66-2-694-1350

### EUROPE

**Austria - Wels**  
Tel: 43-7242-2244-39  
Fax: 43-7242-2244-393

**Denmark - Copenhagen**  
Tel: 45-4450-2828  
Fax: 45-4485-2829

**France - Paris**  
Tel: 33-1-69-53-63-20  
Fax: 33-1-69-30-90-79

**Germany - Munich**  
Tel: 49-89-627-144-0  
Fax: 49-89-627-144-44

**Italy - Milan**  
Tel: 39-0331-742611  
Fax: 39-0331-466781

**Netherlands - Drunen**  
Tel: 31-416-690399  
Fax: 31-416-690340

**Spain - Madrid**  
Tel: 34-91-708-08-90  
Fax: 34-91-708-08-91

**UK - Wokingham**  
Tel: 44-118-921-5869  
Fax: 44-118-921-5820