

Introduction [\(Ask a Question\)](#)

This document demonstrates how to implement basic PolarFire® SoC FPGA designs leveraging the Libero® SoC design tool. The design targets the PolarFire SoC Discovery Kit.

After completing this demo, you will be familiar with the following:

- Creating a Libero SoC Project
- Compiling a Design
- Assigning simple I/O Pin constraints
- Programming the device
- Testing your design

Demo Requirements [\(Ask a Question\)](#)

The following table lists the hardware and software requirements for the demo.

Table 1. Design Requirements

Requirements	Version
Operating System	Windows® 10
Hardware	
PolarFire® SoC Discovery Kit (MPFS-DISCO-KIT)	REV 1
Software	
FlashPro® Express	Available with Libero® SoC installation package.
Libero SoC	

Prerequisites [\(Ask a Question\)](#)

Before you start, download and install [Libero SoC](#) on the host PC. To evaluate the designs using the PolarFire SoC Discovery Kit, use the free Libero SoC Silver license.

Table of Contents

Introduction.....	1
Demo Requirements.....	1
Prerequisites.....	1
1. Creating the Design.....	3
1.1. Launching the Libero SoC Software.....	3
2. Synthesize the Design.....	8
3. Pin Assignments.....	9
3.1. Push Button Switches.....	11
3.2. User LEDs.....	11
4. Setting up the Demo Design.....	13
5. Programming the Device.....	14
6. Running the Design.....	16
7. Design Iterations in Libero SoC	17
8. Revision History.....	18
Microchip FPGA Support.....	19
Microchip Information.....	19
The Microchip Website.....	19
Product Change Notification Service.....	19
Customer Support.....	19
Microchip Devices Code Protection Feature.....	19
Legal Notice.....	20
Trademarks.....	20
Quality Management System.....	21
Worldwide Sales and Service.....	22

1. Creating the Design [\(Ask a Question\)](#)

The following steps describe how to create a design using SmartDesign.

1.1. Launching the Libero SoC Software [\(Ask a Question\)](#)

Follow the instructions to launch the Libero SoC software:

1. To open the **Libero SoC Project Manager**, go to **Start > Microchip Libero SoC v2023.2 > Libero SoC v2023.2**, or double-click the shortcut on the desktop.
2. Create a new project using one of the following options:
 - Click **New** on the **Start Page** tab, as shown in the following figure
 - Go to **Project > New Project** from the Libero SoC menu

Figure 1-1. Libero[®] SoC Project Manager



3. Enter the following information in the **Project Details** page of the **New Project** dialog box, as shown in the following figure:
 - **Project Name:** PolarFire_SoC_fabric
 - **Project Location:** <C:, D:>/
 - **Preferred HDL Type:** Verilog or VHDL
4. Click **Next**.

Figure 1-2. Project Details

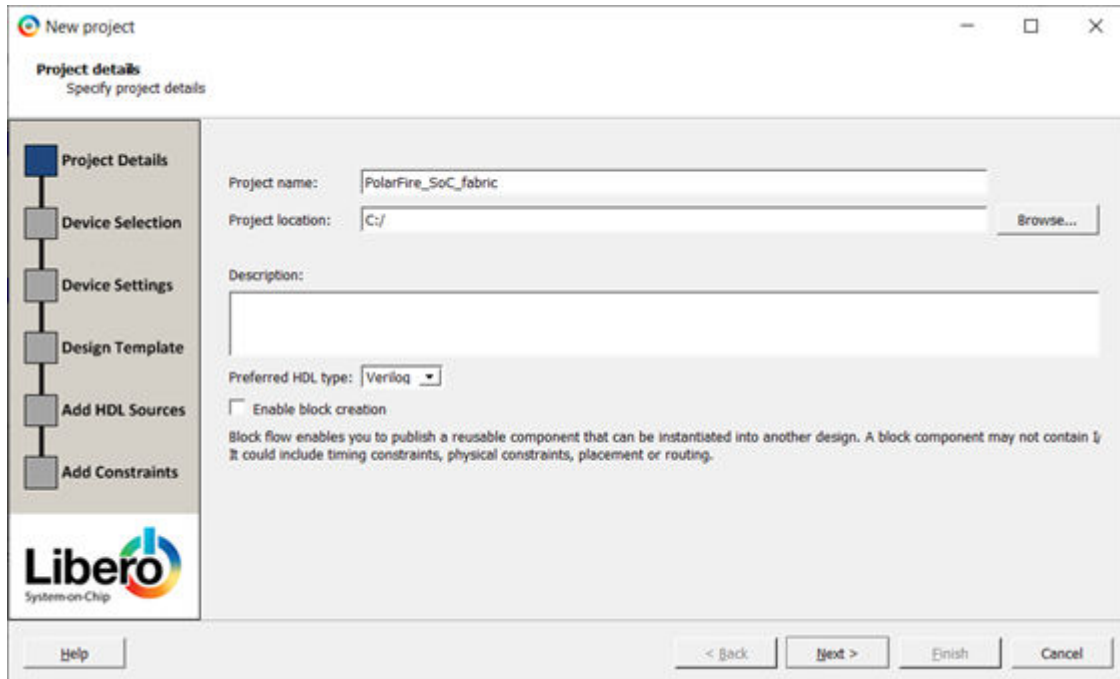

5. Enter the following information in the **Device Selection** page of the **New Project** dialog box and click **Next**:
 - **Family:** PolarFireSoC
 - **Die:** MPFS095T
 - **Package:** FCSG325
 - **Speed:** -1
 - **Range:** EXT

Figure 1-3. Device Selection Settings

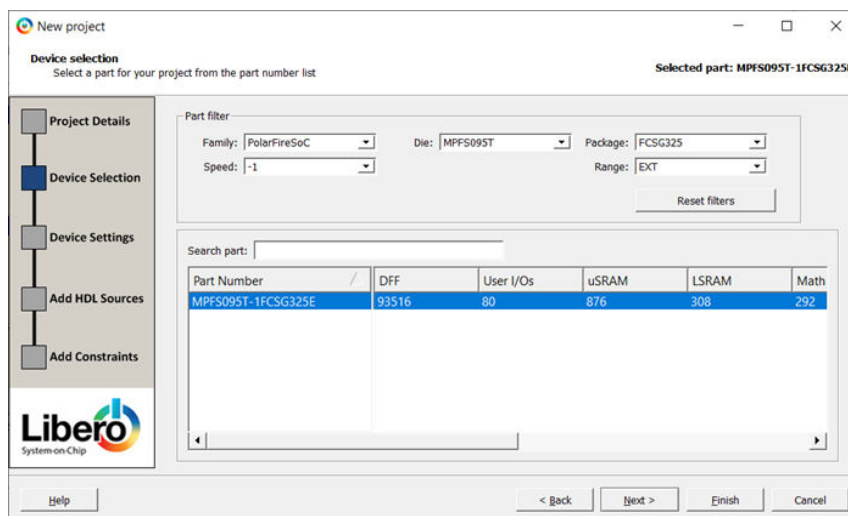

6. Enter the following information in the **Device Settings** page of the **New Project** dialog box and click **Next**:
 - **Core Voltage:** 1.0 (default)

- **Default I/O Technology:** LVCMOS1.8V
- **Reserve Pins for Probes:** Checked (default)
- **System Controller Suspend Mode:** Un-checked (default)

Figure 1-4. Device I/O Settings

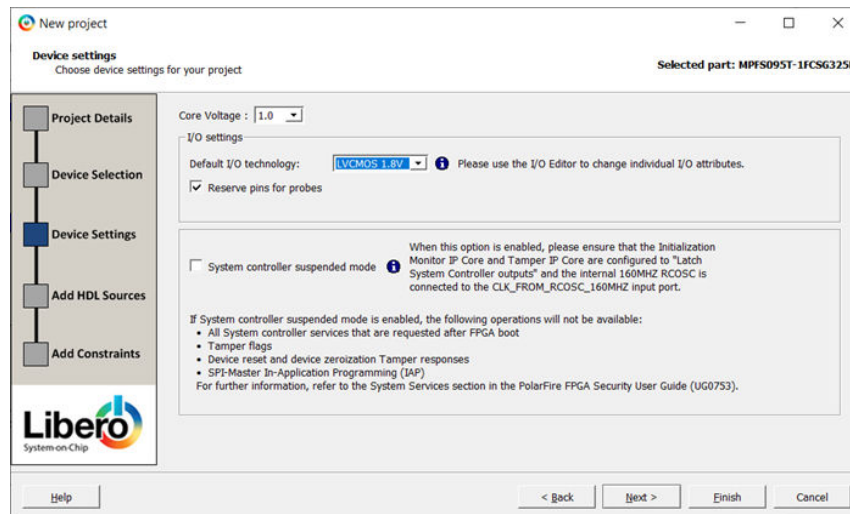

7. Click **Finish**.
8. Open the **SmartDesign canvas** by selecting **File > New > SmartDesign**, or by double-clicking **Create SmartDesign** under **Create Design** in the **Design Flow** tab.

Figure 1-5. Opening the SmartDesign Canvas

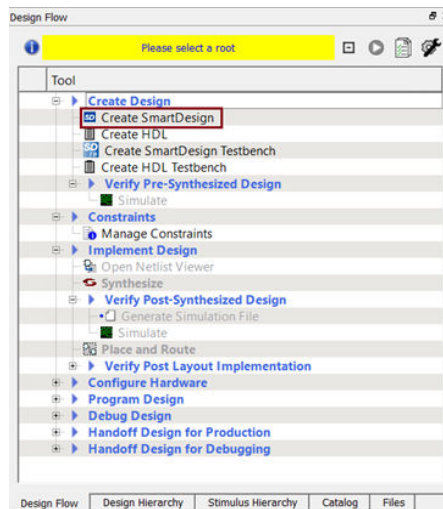

9. Enter **andgate** in the **Create New SmartDesign** dialog box, and click **OK**. For Verilog designs, the name is case sensitive.

Figure 1-6. Entering SmartDesign Name

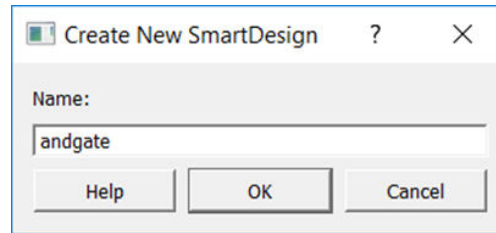

- Expand **Macro Library** in the Libero SoC IP catalog.

Figure 1-7. Macro Library Category of the Libero SoC IP Catalog

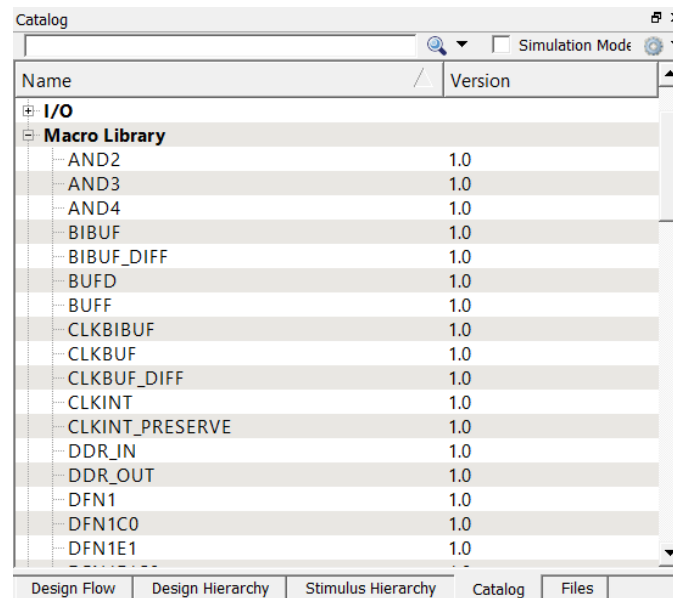

- Drag-and-drop an instance of **AND2** in the **SmartDesign** Canvas.
- In the **SmartDesign** canvas, select A, B, and Y pins. Right-click and select **Promote to Top Level** from the menu, as shown in the following figure. This creates an external connection on the device that can be connected to a switch.

Figure 1-8. Promoting Pins to Top Level

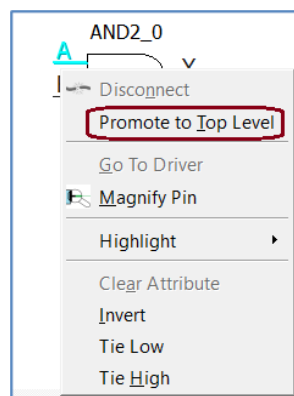

13. After making the connections, the **SmartDesign** canvas is displayed, as shown in the following figure.

Figure 1-9. andgate SmartDesign Canvas

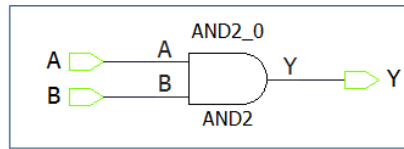

14. Save the design (**File > Save top**).
15. Generate the design by clicking **SmartDesign > Generate Component**, or **Generate Component** on the **SmartDesign** toolbar.
16. Select the **Design Hierarchy** tab and click **Build Hierarchy**.

Figure 1-10. Build Hierarchy

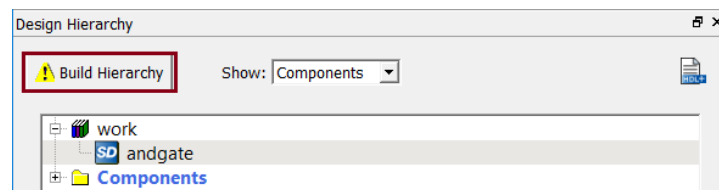

17. Select **andgate** on the **Design Hierarchy** tab. Right-click and select **Set As Root**. **andgate** appears in bold font on the Design Hierarchy tab indicating that it is the root level.

Figure 1-11. Set As Root

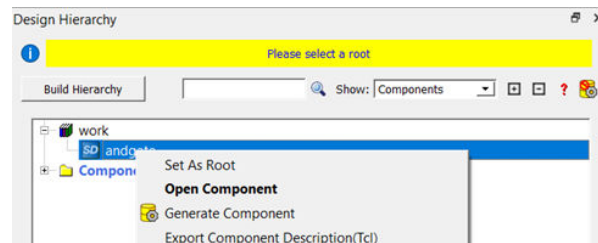

2. Synthesize the Design [\(Ask a Question\)](#)

To synthesize the design with Synplify Pro®, navigate to the **Design Flow** window, expand **Implement Design**, right-click **Synthesize**, and select **Run**, as shown in the following figure.

Figure 2-1. Design Flow—Synthesize

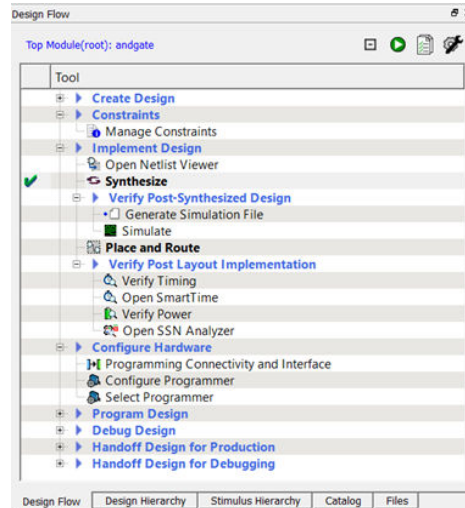

3. Pin Assignments [\(Ask a Question\)](#)

Follow the instructions to assign the pins in the software:

1. Navigate to the **Design Flow** window, expand **Constraints**, right-click **Manage Constraints**, and select **Open Manage Constraints View**.

Figure 3-1. Opening the I/O Editor

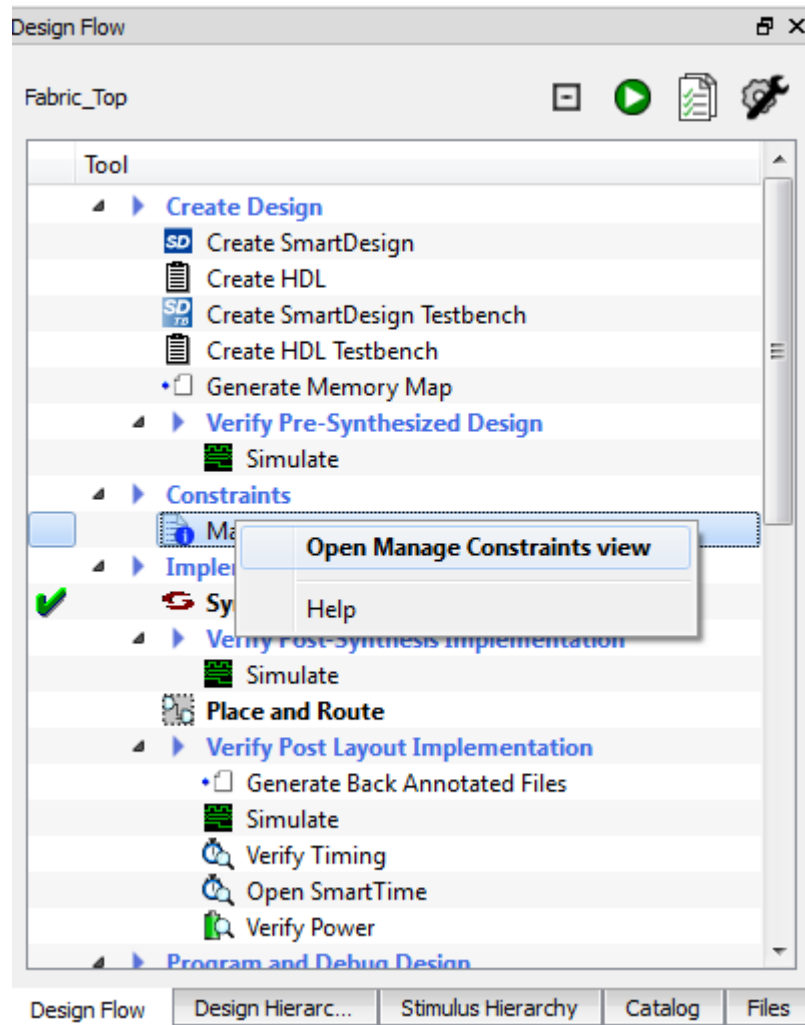

2. In the **Constraint Manager** window, select the **I/O Attributes** tab and click **Edit with I/O Editor**, see the following figure.

Figure 3-2. Constraint Manager Window

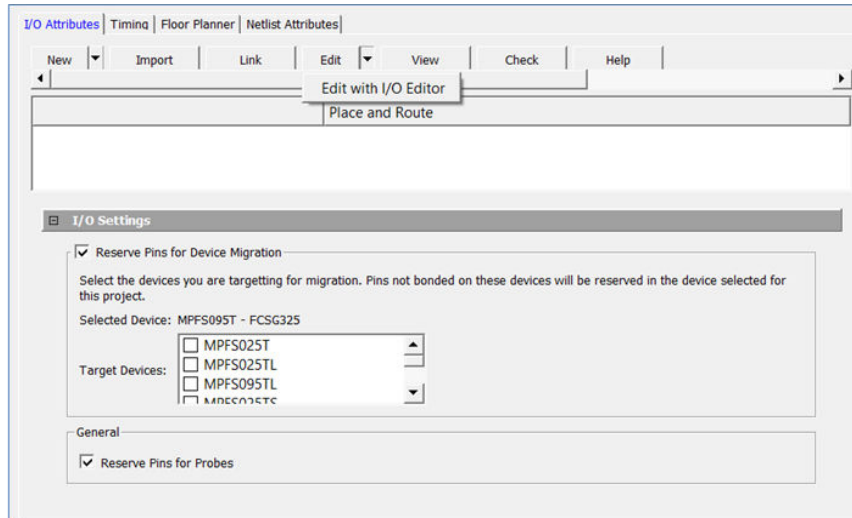

The I/O Editor page appears. See the following figure.

3. Select the **Port View** tab of the I/O Editor.

Figure 3-3. I/O Editor

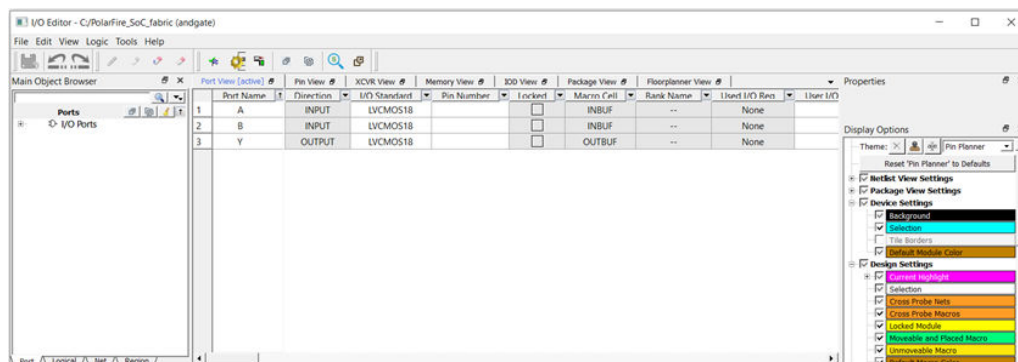

4. Set the **I/O Standard** and **Pin Number** in this window. Confirm that **LVC MOS18** is the I/O Standard for each pin.
5. Navigate to the **Pin Number** column and click **Unassigned** in the **Pin Number** column to see the available I/O pins in **I/O Editor**. Make the following assignments:
 - A - T19
 - B - U18
 - Y - T18

You can type the pin number in the field or use the pull-down menu to select the pin.

6. Select **File > Commit and Check** from the **I/O Attribute Editor** menu. Ensure that the **I/O Editor Log** window has no errors and the connections match as shown in the following figure.

Figure 3-4. Pin Assignments

Port Name	Direction	I/O Standard	Pin Number	Locked	Macro Cell	Rank Name	Used I/O Req	User I/O
1 A	INPUT	LVCMOS18	T19	<input checked="" type="checkbox"/>	INBUF	Bank0	None	
2 B	INPUT	LVCMOS18	U18	<input checked="" type="checkbox"/>	INBUF	Bank0	None	
3 Y	OUTPUT	LVCMOS18	T18	<input checked="" type="checkbox"/>	OUTBUF	Bank0	None	

7. Close the I/O Attribute Editor using **File > Exit**.

3.1. Push Button Switches [\(Ask a Question\)](#)

The PolarFire SoC Discovery Kit comes with two debug push-button switches that are connected to the PolarFire SoC FPGA. The following table lists the onboard push-button switches.

Table 3-1. PolarFire SoC Discovery Kit Pin Number and Pin Name

PolarFire® SoC Discovery Board	PolarFire SoC FPGA Pin Number	PolarFire SoC FPGA Pin Name
SWITCH1	T19	HSIO12NB0
SWITCH2	U18	HSIO15NB0/DQS

The following figure shows the schematics of Push Button.

Figure 3-5. Push Button Schematics

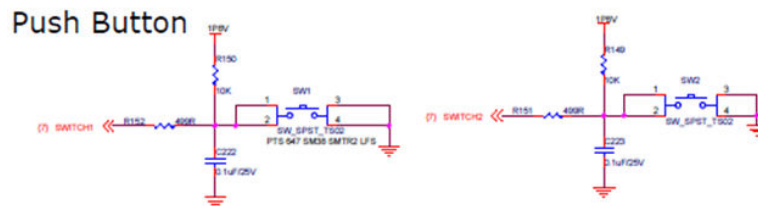

3.2. User LEDs [\(Ask a Question\)](#)

The board provides the access to eight active low LEDs, which are connected to the PolarFire SoC FPGA for debugging applications. The following table lists the onboard debugging LEDs.

Table 3-2. User LEDs

PolarFire® SoC Discovery Board	PolarFire SoC FPGA Pin Number	PolarFire Pin Name
LED1	T18	HSIO12PB0/CLKIN_N_9/CCC_NE_CLKIN_N_9

The following figure shows the user LED schematics.

Figure 3-6. User LED Schematics

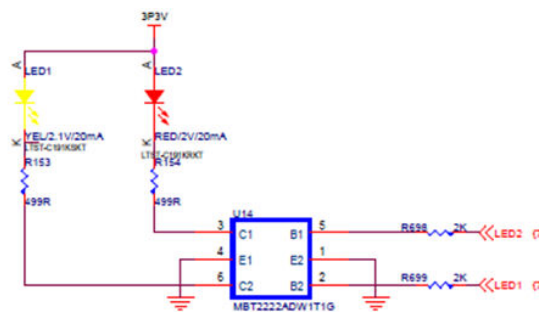

If you click on the green arrow button at the top of the **Design Flow** window, you can run the design all the way through Place and Route.

Figure 3-7. Running the Design Flow

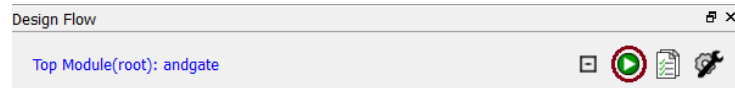

4. Setting up the Demo Design [\(Ask a Question\)](#)

The following figure shows the PolarFire SoC Discovery Kit board.

Figure 4-1. PolarFire SoC Discovery Kit Board

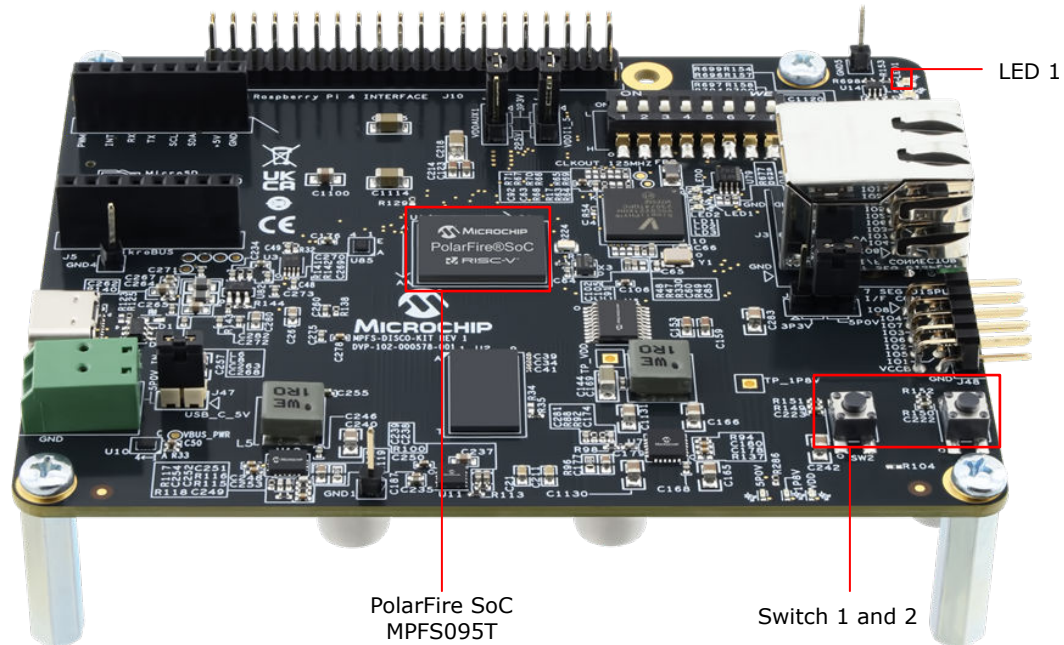

The following steps describe how to setup the PolarFire SoC Discovery Kit to run the demo design:

1. Ensure that the board is powered OFF.
2. Before programming and powering up the PolarFire SoC Discovery board, ensure that the jumpers are positioned, as listed in the following table.

Table 4-1. Jumper Settings

Jumper	Location	Purpose	Settings
J45	Near the Raspberry Pi connector	Select the voltage for I/O bank 5 (Pin 1–2 for 3.3V)	1–2 installed
J46	Near the Raspberry Pi connector	Select the VDDAUX1 voltage <ul style="list-style-type: none"> • Pin 1–2 for 3.3V • Pin 2–3 for 2.5V 	1–2 installed
J47	Near the power block	Select the power source for the board Pin 1–2 for board powered by USB Type C connector J4	1–2 installed
J49	Near the RJ45 connector	Jumper to select the voltage for the external 8-digit 7-segment display <ul style="list-style-type: none"> • Pin 1–2 installed for 3.3V • Pin 2–3 installed for 5.0V 	1–2 installed

3. Connect the USB type-C cable between the J4 USB connector and the host PC.

5. Programming the Device [\(Ask a Question\)](#)

The FlashPro Express runs in batch mode to program the PolarFire SoC MPFS095T on the PolarFire SoC Discovery Kit board.

To program the device, follow these steps:

1. Install the FlashPro5 drivers if prompted. The drivers are in the <Libero SoC v20232.2 Installation Directory>\Designer\fp_drivers folder.
2. To generate the programming file and begin programming, expand **Program Design** in the **Design Flow** window, right-click **Run PROGRAM Action** and select **Run**.

FlashPro Express runs in batch mode and programs the device. Programming messages are visible in the Libero® SoC log window (programmer number may differ).

 **Important:** Do not interrupt the programming sequence.

The following message must be visible in the **Reports View** under **Run PROGRAM Action** when the device is programmed successfully (programmer number may differ): programmer 'E2007ZZUNS': Chain programming PASSED.

Figure 5-1. Program Report

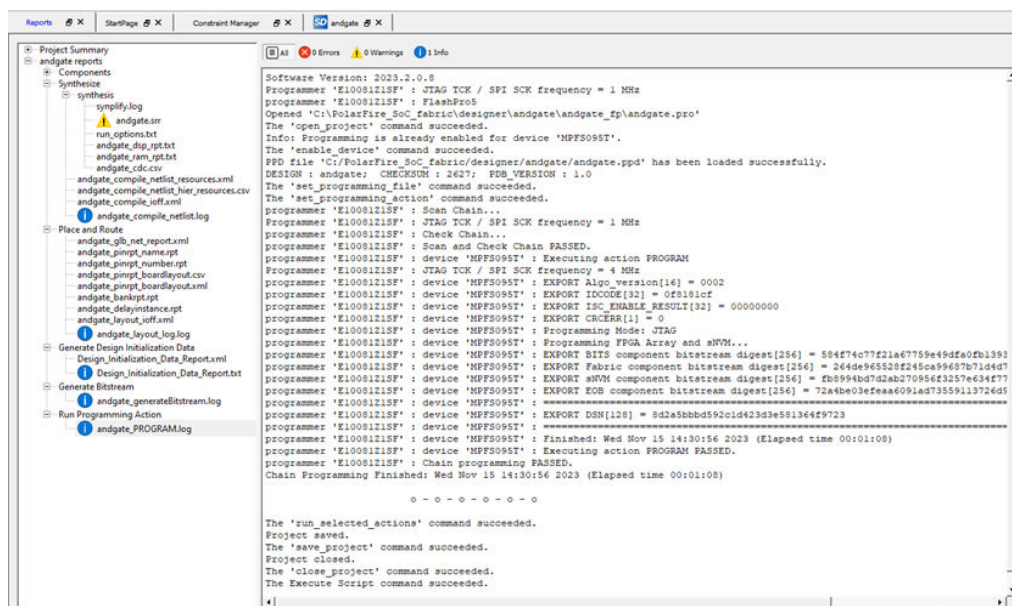

A green check mark appears next to the **Program Design** and **Run PROGRAM Action** in the **Design Flow** window to indicate programming completed successfully.

Figure 5-2. Design Flow Window

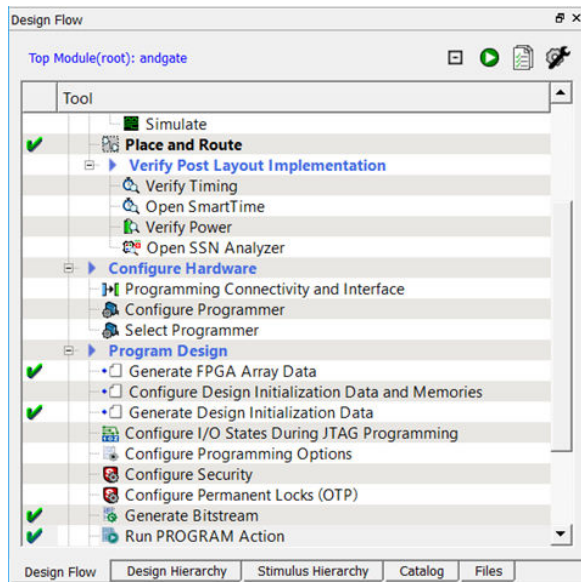

6. Running the Design [\(Ask a Question\)](#)

Follow the instructions to run the application:

1. Release Switch 1 and Switch 2 and observe the pattern of LED 1. LED1 must illuminate.
2. Press Switch 1 and observe the behavior of LED 1. It turns OFF.
3. Press Switch 2 and observe the behavior of LED 1. It turns OFF.
4. Press both the switches and LED 1 turns OFF.
5. Releasing the switch generates a logic one, which illuminates the LED. Invert the input signals to illuminate the LED when both switches are pressed.

7. Design Iterations in Libero SoC [\(Ask a Question\)](#)

Follow the instructions to iterate the design:

1. Reopen the **SmartDesign** Canvas by double-clicking **andgate** on the **Design Hierarchy** tab.
2. Select the **andgate** tab.
3. To bring up the menu, hold the CTRL key and select input ports A and B of AND2_0, and click the right mouse button. Select **Invert** to invert the signals. This is built into the SmartDesign capabilities to invert or Tie off any I/O.
4. Generate the Component. This resets the rest of the compilation functions but keeps the I/O constraints.
5. To run all the steps in between and reprogram the device, right-click **Run PROGRAM Action** on the **Design Flow** window and select **Update and Run**. If it seems to be taking a while, check to see if the **Warning** dialog box about running in non-Timing-driven mode is behind your active window.

Observe the correct behavior on the board by pressing both switches simultaneously to illuminate LED1.

8. Revision History [\(Ask a Question\)](#)

The revision history describes the changes that were implemented in the document. The changes are listed by revision, starting with the most current publication.

Revision	Date	Description
B	07/2024	Updated the I/O Standard to "LVCMOS18" from "LVCMOS33" in step 3 of Pin Assignments section
A	01/2024	Initial Revision

Microchip FPGA Support

Microchip FPGA products group backs its products with various support services, including Customer Service, Customer Technical Support Center, a website, and worldwide sales offices. Customers are suggested to visit Microchip online resources prior to contacting support as it is very likely that their queries have been already answered.

Contact Technical Support Center through the website at www.microchip.com/support. Mention the FPGA Device Part number, select appropriate case category, and upload design files while creating a technical support case.

Contact Customer Service for non-technical product support, such as product pricing, product upgrades, update information, order status, and authorization.

- From North America, call **800.262.1060**
- From the rest of the world, call **650.318.4460**
- Fax, from anywhere in the world, **650.318.8044**

Microchip Information

The Microchip Website

Microchip provides online support via our website at www.microchip.com/. This website is used to make files and information easily available to customers. Some of the content available includes:

- **Product Support** – Data sheets and errata, application notes and sample programs, design resources, user's guides and hardware support documents, latest software releases and archived software
- **General Technical Support** – Frequently Asked Questions (FAQs), technical support requests, online discussion groups, Microchip design partner program member listing
- **Business of Microchip** – Product selector and ordering guides, latest Microchip press releases, listing of seminars and events, listings of Microchip sales offices, distributors and factory representatives

Product Change Notification Service

Microchip's product change notification service helps keep customers current on Microchip products. Subscribers will receive email notification whenever there are changes, updates, revisions or errata related to a specified product family or development tool of interest.

To register, go to www.microchip.com/pcn and follow the registration instructions.

Customer Support

Users of Microchip products can receive assistance through several channels:

- Distributor or Representative
- Local Sales Office
- Embedded Solutions Engineer (ESE)
- Technical Support

Customers should contact their distributor, representative or ESE for support. Local sales offices are also available to help customers. A listing of sales offices and locations is included in this document.

Technical support is available through the website at: www.microchip.com/support

Microchip Devices Code Protection Feature

Note the following details of the code protection feature on Microchip products:

- Microchip products meet the specifications contained in their particular Microchip Data Sheet.
- Microchip believes that its family of products is secure when used in the intended manner, within operating specifications, and under normal conditions.
- Microchip values and aggressively protects its intellectual property rights. Attempts to breach the code protection features of Microchip product is strictly prohibited and may violate the Digital Millennium Copyright Act.
- Neither Microchip nor any other semiconductor manufacturer can guarantee the security of its code. Code protection does not mean that we are guaranteeing the product is “unbreakable”. Code protection is constantly evolving. Microchip is committed to continuously improving the code protection features of our products.

Legal Notice

This publication and the information herein may be used only with Microchip products, including to design, test, and integrate Microchip products with your application. Use of this information in any other manner violates these terms. Information regarding device applications is provided only for your convenience and may be superseded by updates. It is your responsibility to ensure that your application meets with your specifications. Contact your local Microchip sales office for additional support or, obtain additional support at www.microchip.com/en-us/support/design-help/client-support-services.

THIS INFORMATION IS PROVIDED BY MICROCHIP “AS IS”. MICROCHIP MAKES NO REPRESENTATIONS OR WARRANTIES OF ANY KIND WHETHER EXPRESS OR IMPLIED, WRITTEN OR ORAL, STATUTORY OR OTHERWISE, RELATED TO THE INFORMATION INCLUDING BUT NOT LIMITED TO ANY IMPLIED WARRANTIES OF NON-INFRINGEMENT, MERCHANTABILITY, AND FITNESS FOR A PARTICULAR PURPOSE, OR WARRANTIES RELATED TO ITS CONDITION, QUALITY, OR PERFORMANCE.

IN NO EVENT WILL MICROCHIP BE LIABLE FOR ANY INDIRECT, SPECIAL, PUNITIVE, INCIDENTAL, OR CONSEQUENTIAL LOSS, DAMAGE, COST, OR EXPENSE OF ANY KIND WHATSOEVER RELATED TO THE INFORMATION OR ITS USE, HOWEVER CAUSED, EVEN IF MICROCHIP HAS BEEN ADVISED OF THE POSSIBILITY OR THE DAMAGES ARE FORESEEABLE. TO THE FULLEST EXTENT ALLOWED BY LAW, MICROCHIP’S TOTAL LIABILITY ON ALL CLAIMS IN ANY WAY RELATED TO THE INFORMATION OR ITS USE WILL NOT EXCEED THE AMOUNT OF FEES, IF ANY, THAT YOU HAVE PAID DIRECTLY TO MICROCHIP FOR THE INFORMATION.

Use of Microchip devices in life support and/or safety applications is entirely at the buyer’s risk, and the buyer agrees to defend, indemnify and hold harmless Microchip from any and all damages, claims, suits, or expenses resulting from such use. No licenses are conveyed, implicitly or otherwise, under any Microchip intellectual property rights unless otherwise stated.

Trademarks

The Microchip name and logo, the Microchip logo, Adaptec, AVR, AVR logo, AVR Freaks, BesTime, BitCloud, CryptoMemory, CryptoRF, dsPIC, flexPWR, HELDO, IGLOO, JukeBlox, KeeLoq, Kleer, LANCheck, LinkMD, maXStylus, maXTouch, MediaLB, megaAVR, Microsemi, Microsemi logo, MOST, MOST logo, MPLAB, OptoLyzer, PIC, picoPower, PICSTART, PIC32 logo, PolarFire, Prochip Designer, QTouch, SAM-BA, SenGenuity, SpyNIC, SST, SST Logo, SuperFlash, Symmetricom, SyncServer, Tachyon, TimeSource, tinyAVR, UNI/O, Vectron, and XMEGA are registered trademarks of Microchip Technology Incorporated in the U.S.A. and other countries.

AgileSwitch, ClockWorks, The Embedded Control Solutions Company, EtherSynch, Flashtec, Hyper Speed Control, HyperLight Load, Libero, motorBench, mTouch, Powermite 3, Precision Edge, ProASIC, ProASIC Plus, ProASIC Plus logo, Quiet-Wire, SmartFusion, SyncWorld, TimeCesium, TimeHub, TimePictra, TimeProvider, and ZL are registered trademarks of Microchip Technology Incorporated in the U.S.A.

Adjacent Key Suppression, AKS, Analog-for-the-Digital Age, Any Capacitor, AnyIn, AnyOut, Augmented Switching, BlueSky, BodyCom, Clockstudio, CodeGuard, CryptoAuthentication, CryptoAutomotive, CryptoCompanion, CryptoController, dsPICDEM, dsPICDEM.net, Dynamic

Average Matching, DAM, ECAN, Espresso T1S, EtherGREEN, EyeOpen, GridTime, IdealBridge, IGaT, In-Circuit Serial Programming, ICSP, INICnet, Intelligent Paralleling, IntelliMOS, Inter-Chip Connectivity, JitterBlocker, Knob-on-Display, MarginLink, maxCrypto, maxView, memBrain, Mindi, MiWi, MPASM, MPF, MPLAB Certified logo, MPLIB, MPLINK, mSiC, MultiTRAK, NetDetach, Omniscient Code Generation, PICDEM, PICDEM.net, PICkit, PICtail, Power MOS IV, Power MOS 7, PowerSmart, PureSilicon, QMatrix, REAL ICE, Ripple Blocker, RTAX, RTG4, SAM-ICE, Serial Quad I/O, simpleMAP, SimpliPHY, SmartBuffer, SmartHLS, SMART-I.S., storClad, SQL, SuperSwitcher, SuperSwitcher II, Switchtec, SynchroPHY, Total Endurance, Trusted Time, TSHARC, Turing, USBCheck, VariSense, VectorBlox, VeriPHY, ViewSpan, WiperLock, XpressConnect, and ZENA are trademarks of Microchip Technology Incorporated in the U.S.A. and other countries.

SQTP is a service mark of Microchip Technology Incorporated in the U.S.A.

The Adaptec logo, Frequency on Demand, Silicon Storage Technology, and Symmcom are registered trademarks of Microchip Technology Inc. in other countries.

GestIC is a registered trademark of Microchip Technology Germany II GmbH & Co. KG, a subsidiary of Microchip Technology Inc., in other countries.

All other trademarks mentioned herein are property of their respective companies.

© 2025, Microchip Technology Incorporated and its subsidiaries. All Rights Reserved.

ISBN: 978-1-6683-4978-6

Quality Management System

For information regarding Microchip's Quality Management Systems, please visit www.microchip.com/quality.

Worldwide Sales and Service

AMERICAS	ASIA/PACIFIC	ASIA/PACIFIC	EUROPE
<p>Corporate Office 2355 West Chandler Blvd. Chandler, AZ 85224-6199 Tel: 480-792-7200 Fax: 480-792-7277 Technical Support: www.microchip.com/support Web Address: www.microchip.com</p> <p>Atlanta Duluth, GA Tel: 678-957-9614 Fax: 678-957-1455</p> <p>Austin, TX Tel: 512-257-3370</p> <p>Boston Westborough, MA Tel: 774-760-0087 Fax: 774-760-0088</p> <p>Chicago Itasca, IL Tel: 630-285-0071 Fax: 630-285-0075</p> <p>Dallas Addison, TX Tel: 972-818-7423 Fax: 972-818-2924</p> <p>Detroit Novi, MI Tel: 248-848-4000</p> <p>Houston, TX Tel: 281-894-5983</p> <p>Indianapolis Noblesville, IN Tel: 317-773-8323 Fax: 317-773-5453 Tel: 317-536-2380</p> <p>Los Angeles Mission Viejo, CA Tel: 949-462-9523 Fax: 949-462-9608 Tel: 951-273-7800</p> <p>Raleigh, NC Tel: 919-844-7510</p> <p>New York, NY Tel: 631-435-6000</p> <p>San Jose, CA Tel: 408-735-9110 Tel: 408-436-4270</p> <p>Canada - Toronto Tel: 905-695-1980 Fax: 905-695-2078</p>	<p>Australia - Sydney Tel: 61-2-9868-6733</p> <p>China - Beijing Tel: 86-10-8569-7000</p> <p>China - Chengdu Tel: 86-28-8665-5511</p> <p>China - Chongqing Tel: 86-23-8980-9588</p> <p>China - Dongguan Tel: 86-769-8702-9880</p> <p>China - Guangzhou Tel: 86-20-8755-8029</p> <p>China - Hangzhou Tel: 86-571-8792-8115</p> <p>China - Hong Kong SAR Tel: 852-2943-5100</p> <p>China - Nanjing Tel: 86-25-8473-2460</p> <p>China - Qingdao Tel: 86-532-8502-7355</p> <p>China - Shanghai Tel: 86-21-3326-8000</p> <p>China - Shenyang Tel: 86-24-2334-2829</p> <p>China - Shenzhen Tel: 86-755-8864-2200</p> <p>China - Suzhou Tel: 86-186-6233-1526</p> <p>China - Wuhan Tel: 86-27-5980-5300</p> <p>China - Xian Tel: 86-29-8833-7252</p> <p>China - Xiamen Tel: 86-592-2388138</p> <p>China - Zhuhai Tel: 86-756-3210040</p>	<p>India - Bangalore Tel: 91-80-3090-4444</p> <p>India - New Delhi Tel: 91-11-4160-8631</p> <p>India - Pune Tel: 91-20-4121-0141</p> <p>Japan - Osaka Tel: 81-6-6152-7160</p> <p>Japan - Tokyo Tel: 81-3-6880-3770</p> <p>Korea - Daegu Tel: 82-53-744-4301</p> <p>Korea - Seoul Tel: 82-2-554-7200</p> <p>Malaysia - Kuala Lumpur Tel: 60-3-7651-7906</p> <p>Malaysia - Penang Tel: 60-4-227-8870</p> <p>Philippines - Manila Tel: 63-2-634-9065</p> <p>Singapore Tel: 65-6334-8870</p> <p>Taiwan - Hsin Chu Tel: 886-3-577-8366</p> <p>Taiwan - Kaohsiung Tel: 886-7-213-7830</p> <p>Taiwan - Taipei Tel: 886-2-2508-8600</p> <p>Thailand - Bangkok Tel: 66-2-694-1351</p> <p>Vietnam - Ho Chi Minh Tel: 84-28-5448-2100</p>	<p>Austria - Wels Tel: 43-7242-2244-39 Fax: 43-7242-2244-393</p> <p>Denmark - Copenhagen Tel: 45-4485-5910 Fax: 45-4485-2829</p> <p>Finland - Espoo Tel: 358-9-4520-820</p> <p>France - Paris Tel: 33-1-69-53-63-20 Fax: 33-1-69-30-90-79</p> <p>Germany - Garching Tel: 49-8931-9700</p> <p>Germany - Haan Tel: 49-2129-3766400</p> <p>Germany - Heilbronn Tel: 49-7131-72400</p> <p>Germany - Karlsruhe Tel: 49-721-625370</p> <p>Germany - Munich Tel: 49-89-627-144-0 Fax: 49-89-627-144-44</p> <p>Germany - Rosenheim Tel: 49-8031-354-560</p> <p>Israel - Hod Hasharon Tel: 972-9-775-5100</p> <p>Italy - Milan Tel: 39-0331-742611 Fax: 39-0331-466781</p> <p>Italy - Padova Tel: 39-049-7625286</p> <p>Netherlands - Drunen Tel: 31-416-690399 Fax: 31-416-690340</p> <p>Norway - Trondheim Tel: 47-72884388</p> <p>Poland - Warsaw Tel: 48-22-3325737</p> <p>Romania - Bucharest Tel: 40-21-407-87-50</p> <p>Spain - Madrid Tel: 34-91-708-08-90 Fax: 34-91-708-08-91</p> <p>Sweden - Gothenberg Tel: 46-31-704-60-40</p> <p>Sweden - Stockholm Tel: 46-8-5090-4654</p> <p>UK - Wokingham Tel: 44-118-921-5800 Fax: 44-118-921-5820</p>